

System SLIO

IM | 053-1PN01 | Manual

HB300 | IM | 053-1PN01 | en | 22-30

Interface module PROFINET - IM 053PN



YASKAWA Europe GmbH
Philipp-Reis-Str. 6
65795 Hattersheim
Germany
Tel.: +49 6196 569-300
Fax: +49 6196 569-398
Email: info@yaskawa.eu
Internet: www.yaskawa.eu.com

Table of contents

1	General	5
1.1	Copyright © YASKAWA Europe GmbH.....	5
1.2	About this manual.....	6
1.3	Safety information.....	7
2	Basics and mounting	8
2.1	Safety notes for the user.....	8
2.2	System conception.....	9
2.2.1	Overview.....	9
2.2.2	Components.....	10
2.2.3	Accessories.....	13
2.2.4	Hardware revision.....	15
2.3	Dimensions.....	15
2.4	Mounting bus coupler.....	18
2.5	Wiring.....	20
2.5.1	Wiring bus coupler.....	20
2.5.2	Wiring 8x periphery modules.....	23
2.5.3	Wiring 16x periphery modules.....	25
2.5.4	Wiring power modules.....	26
2.6	Demounting.....	30
2.6.1	Demounting bus coupler.....	30
2.6.2	Demounting 8x periphery modules.....	32
2.6.3	Demounting 16x periphery modules.....	35
2.7	Trouble shooting - LEDs.....	38
2.8	Industrial security and installation guidelines.....	39
2.8.1	Industrial security in information technology.....	39
2.8.2	Installation guidelines.....	41
2.9	General data for the System SLIO.....	43
2.9.1	Use in difficult operating conditions.....	45
2.10	System SLIO product variants for extended application range.....	46
3	Hardware description	47
3.1	Properties.....	47
3.2	Structure.....	48
3.2.1	Interfaces.....	48
3.2.2	LEDs.....	51
3.3	Technical data.....	53
4	Deployment	55
4.1	Basics PROFINET.....	55
4.2	PROFINET installation guidelines.....	57
4.3	Accessing the System SLIO.....	59
4.3.1	General.....	59
4.3.2	Accessing the I/O area.....	60
4.3.3	Accessing the parameter data.....	61
4.3.4	Accessing diagnostics data.....	61
4.4	Project engineering.....	62
4.4.1	Parameter data.....	65
4.5	Web server.....	67
4.6	Free Module Mapping (FMM).....	72

4.6.1 Overview.....	72
4.6.2 FMM configuration.....	73
4.6.3 Examples.....	74
4.7 Easy Maintenance.....	78
4.7.1 Examples.....	78
4.8 Isochronous mode (IRT).....	81
4.9 Firmware update.....	82
4.10 Replacement PROFINET IM 053-1PN00 by IM 053-1PN01.....	82
4.11 Device replacement without exchangeable medium/PG.....	83
4.12 Hardware and diagnostic interrupt.....	84
4.12.1 Hardware interrupt.....	84
4.12.2 Diagnostic interrupt.....	85
4.13 I&M data.....	91
4.14 Index overview.....	93
Appendix.....	95
A History of changes.....	97

1 General

1.1 Copyright © YASKAWA Europe GmbH

All Rights Reserved

This document contains proprietary information of Yaskawa and is not to be disclosed or used except in accordance with applicable agreements.

This material is protected by copyright laws. It may not be reproduced, distributed, or altered in any fashion by any entity (either internal or external to Yaskawa) except in accordance with applicable agreements, contracts or licensing, without the express written consent of Yaskawa and the business management owner of the material.

For permission to reproduce or distribute, please contact: YASKAWA Europe GmbH, European Headquarters, Philipp-Reis-Str. 6, 65795 Hattersheim, Germany

Tel.: +49 6196 569 300

Fax.: +49 6196 569 398

Email: info@yaskawa.eu

Internet: www.yaskawa.eu.com

EC conformity declaration

Hereby, YASKAWA Europe GmbH declares that the products and systems are in compliance with the essential requirements and other relevant provisions. Conformity is indicated by the CE marking affixed to the product.

Conformity Information

For more information regarding CE marking and Declaration of Conformity (DoC), please contact your local representative of YASKAWA Europe GmbH.

Trademarks

SLIO and SPEED7 are registered trademarks of YASKAWA Europe GmbH.

PROFINET is a registered trademark of PROFIBUS and PROFINET International (PI).

SIMATIC and STEP are registered trademarks of Siemens AG.

All other trademarks, logos and service or product marks specified herein are owned by their respective companies.

General terms of use

Every effort has been made to ensure that the information contained in this document was complete and accurate at the time of publishing. We cannot guarantee that the information is free of errors, and we reserve the right to change the information at any time. There is no obligation to inform the customer about any changes. The customer is requested to actively keep his documents up to date. The customer is always responsible for the deployment of the products with the associated documentation, taking into account the applicable directives and standards.

This documentation describes all hardware and software units and functions known today. It is possible that units are described that do not exist at the customer. The exact scope of delivery is described in the respective purchase contract.

Document support

Contact your local representative of YASKAWA Europe GmbH if you have errors or questions regarding the content of this document. You can reach YASKAWA Europe GmbH via the following contact:

Email: Documentation.HER@yaskawa.eu

About this manual

Technical support

Contact your local representative of YASKAWA Europe GmbH if you encounter problems or have questions regarding the product. If such a location is not available, you can reach the Yaskawa customer service via the following contact:

YASKAWA Europe GmbH,
European Headquarters, Philipp-Reis-Str. 6, 65795 Hattersheim, Germany
Tel.: +49 6196 569 500 (hotline)
Email: support@yaskawa.eu

1.2 About this manual

Objective and contents

This manual describes the IM 053PN of the System SLIO.

- It describes the structure, configuration and application.
- The manual is targeted at users who have a background in automation technology.
- The manual consists of chapters. Each chapter describes a completed topic.
- For guidance, the manual provides:
 - An overall table of contents at the beginning of the manual.
 - References with pages numbers.

Validity of the documentation

Product	Order no.	as of state:	
IM 053PN	053-1PN01	HW: 01	FW: V1.0.7

Icons Headings

Important passages in the text are highlighted by following icons and headings:



DANGER!

Immediate or likely danger. Personal injury is possible.



CAUTION!

Damages to property is likely if these warnings are not heeded.



Supplementary information and useful tips.

1.3 Safety information

Applications conforming with specifications

The system is constructed and produced for:

- communication and process control
- general control and automation tasks
- industrial applications
- operation within the environmental conditions specified in the technical data
- installation into a cubicle



DANGER!

This device is not certified for applications in

- in explosive environments (EX-zone)

Documentation

The manual must be available to all personnel in the

- project design department
- installation department
- commissioning
- operation



CAUTION!

The following conditions must be met before using or commissioning the components described in this manual:

- Hardware modifications to the process control system should only be carried out when the system has been disconnected from power!
- Installation and hardware modifications only by properly trained personnel.
- The national rules and regulations of the respective country must be satisfied (installation, safety, EMC ...)

Disposal

National rules and regulations apply to the disposal of the unit!

2 Basics and mounting

2.1 Safety notes for the user



DANGER!

Protection against dangerous voltages

- When using System SLIO modules, the user must be protected from touching hazardous voltage.
- You must therefore create an insulation concept for your system that includes safe separation of the potential areas of ELV and hazardous voltage.
- Here, observe the insulation voltages between the potential areas specified for the System SLIO modules and take suitable measures, such as using PELV/SELV power supplies for System SLIO modules.

Handling of electrostatic sensitive modules

The modules are equipped with highly integrated components in MOS technology. These components are highly sensitive to over-voltages that occur, e.g. with electrostatic discharge. The following symbol is used to identify these hazardous modules:



The symbol is located on modules, module racks or on packaging and thus indicates electrostatic sensitive modules. Electrostatic sensitive modules can be destroyed by energies and voltages that are far below the limits of human perception. If a person who is not electrically discharged handles electrostatic sensitive modules, voltages can occur and damage components and thus impair the functionality of the modules or render the modules unusable. Modules damaged in this way are in most cases not immediately recognized as faulty. The error can only appear after a long period of operation. Components damaged by static discharge can show temporary faults when exposed to temperature changes, vibrations or load changes. Only the consistent use of protective devices and responsible observance of the handling rules can effectively prevent malfunctions and failures on electrostatic sensitive modules.

Shipping of modules

Please always use the original packaging for shipping.

Measurement and modification of electrostatic sensitive modules

For measurements on electrostatic sensitive modules the following must be observed:

- Floating measuring instruments must be discharged before use.
- Measuring instruments used must be grounded.

When modifying electrostatic sensitive modules, ensure that a grounded soldering iron is used.



CAUTION!

When working with and on electrostatic sensitive modules, make sure that personnel and equipment are adequately grounded.

2.2 System conception

2.2.1 Overview

The System SLIO is a modular automation system for assembly on a 35mm mounting rail. By means of the periphery modules with 2, 4, 8 and 16 channels this system may properly be adapted matching to your automation tasks. The wiring complexity is low, because the supply of the DC 24V power section supply is integrated to the backplane bus and defective modules may be replaced with standing wiring. By deployment of the power modules in contrasting colors within the system, further isolated areas may be defined for the DC 24V power section supply, respectively the electronic power supply may be extended with 2A.

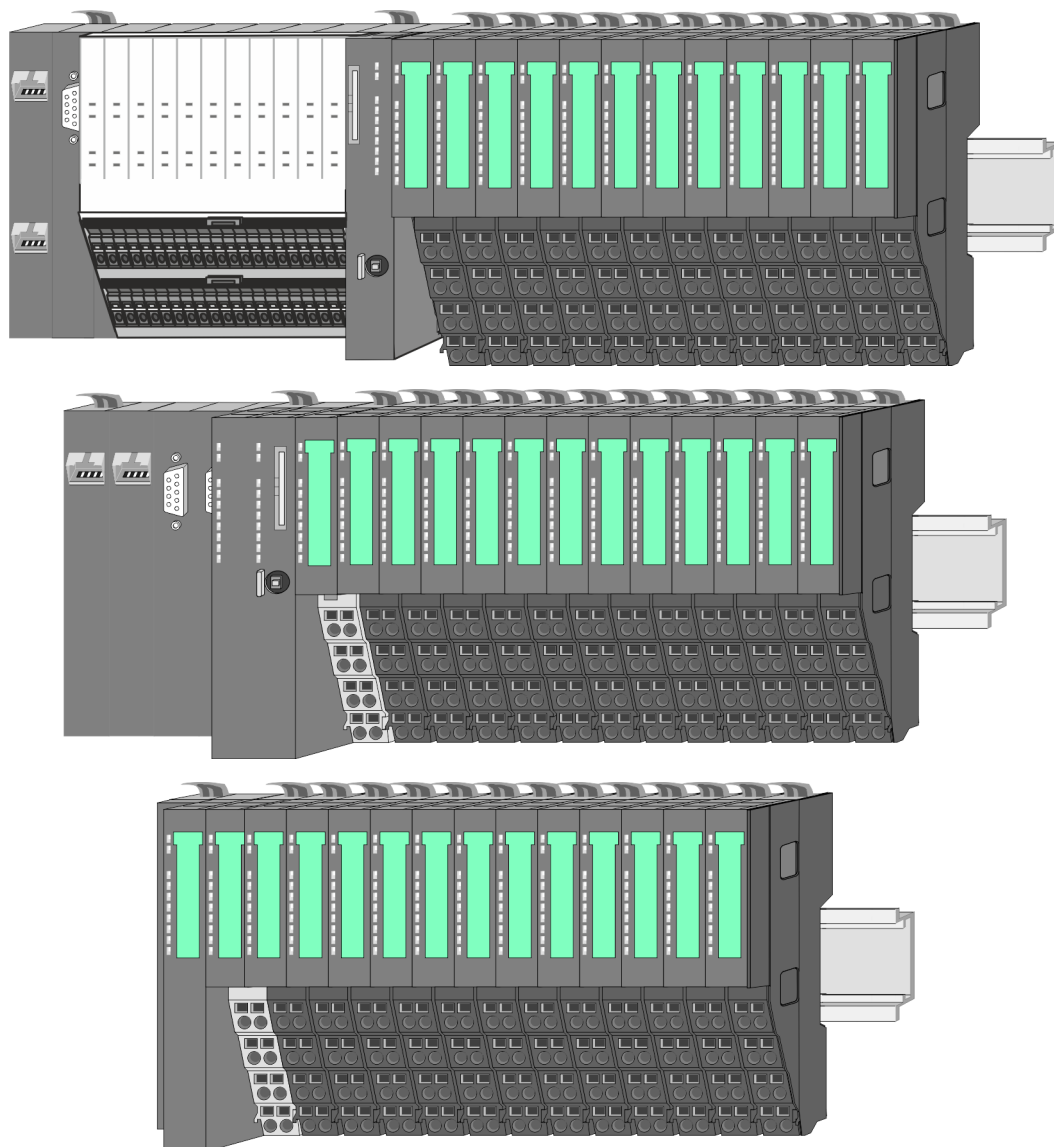

2.2.2 Components

- CPU (head module)
- Bus coupler (head module)
- Line extension
- 8x periphery modules
- 16x periphery modules
- Power modules
- Accessories



CAUTION!

Only Yaskawa modules may be combined. A mixed operation with third-party modules is not allowed!

CPU 01xC

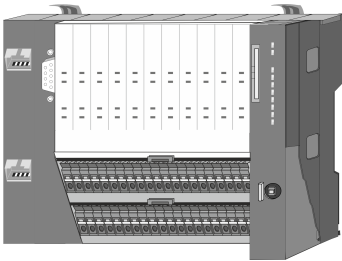

With the CPU 01xC electronic, input/output components and power supply are integrated to one casing. In addition, up to 64 periphery modules of the System SLIO can be connected to the backplane bus. As head module via the integrated power module for power supply CPU electronic and the I/O components are supplied as well as the electronic of the periphery modules, which are connected via backplane bus. To connect the power supply of the I/O components and for DC 24V power section supply of via backplane bus connected periphery modules, the CPU has removable connectors. By installing of up to 64 periphery modules at the backplane bus, these are electrically connected, this means these are assigned to the backplane bus, the electronic modules are power supplied and each periphery module is connected to the DC 24V power section supply.

CPU 01x



With this CPU 01x, CPU electronic and power supply are integrated to one casing. As head module, via the integrated power module for power supply, CPU electronic and the electronic of the connected periphery modules are supplied. The DC 24V power section supply for the linked periphery modules is established via a further connection of the power module. By installing of up to 64 periphery modules at the backplane bus, these are electrically connected, this means these are assigned to the backplane bus, the electronic modules are power supplied and each periphery module is connected to the DC 24V power section supply.



CAUTION!

CPU part and power module may not be separated!
Here you may only exchange the electronic module!

Bus coupler

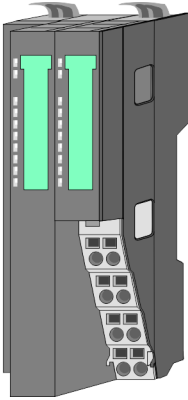

With a bus coupler bus interface and power module is integrated to one casing. With the bus interface you get access to a subordinated bus system. As head module, via the integrated power module for power supply, bus interface and the electronic of the connected periphery modules are supplied. The DC 24V power section supply for the linked periphery modules is established via a further connection of the power module. By installing of up to 64 periphery modules at the bus coupler, these are electrically connected, this means these are assigned to the backplane bus, the electronic modules are power supplied and each periphery module is connected to the DC 24V power section supply.



CAUTION!

Bus interface and power module may not be separated!
Here you may only exchange the electronic module!

Line extension

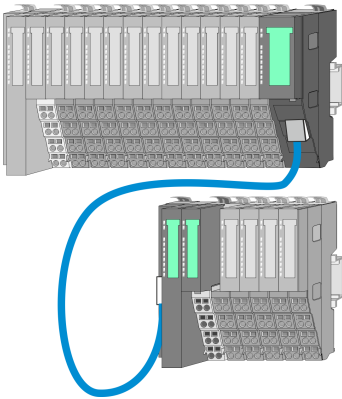

In the System SLIO there is the possibility to place up to 64 modules in on line. By means of the line extension you can divide this line into several lines. Here you have to place a line extension master at each end of a line and the subsequent line has to start with a line extension slave. Master and slave are to be connected via a special connecting cable. In this way, you can divide a line on up to 5 lines. For each line extension the maximum number of pluggable modules at the System SLIO bus is decreased by 1. To use the line extension no special configuration is required.



Please note that some modules do not support line extensions due to the system. For more information, see the 'System SLIO - Compatibility List' at www.yaskawa.eu.com

Periphery modules

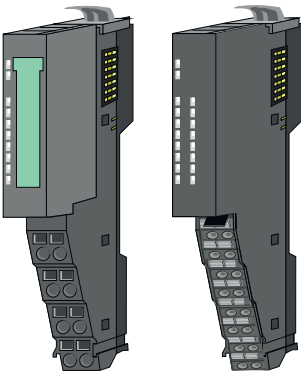

The periphery modules are available in the following 2 versions, whereby of each the electronic part can be replaced with standing wiring:

- 8x periphery module for a maximum of 8 channels.
- 16x periphery module for a maximum of 16 channels.

8x periphery modules

Each 8x periphery module consists of a *terminal* and an *electronic module*.

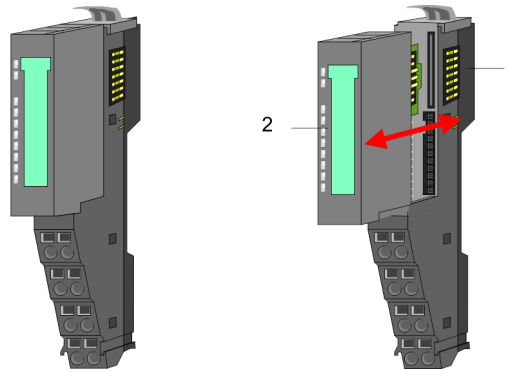

- 1 Terminal module
- 2 Electronic module

Terminal module

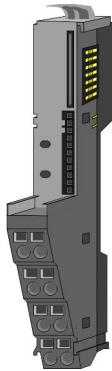

The *terminal* module serves to carry the electronic module, contains the backplane bus with power supply for the electronic, the DC 24V power section supply and the staircase-shaped terminal for wiring. Additionally the terminal module has a locking system for fixing at a mounting rail. By means of this locking system your system may be assembled outside of your switchgear cabinet to be later mounted there as whole system.

Electronic module

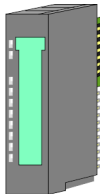

The functionality of a periphery module is defined by the *electronic module*, which is mounted to the terminal module by a sliding mechanism. With an error the defective electronic module may be exchanged for a functional module with standing installation. At the front side there are LEDs for status indication. For simple wiring each module shows corresponding connection information at the front and at the side.

16x periphery modules

Each 16x periphery module consists of an *electronic unit* and a *terminal block*.

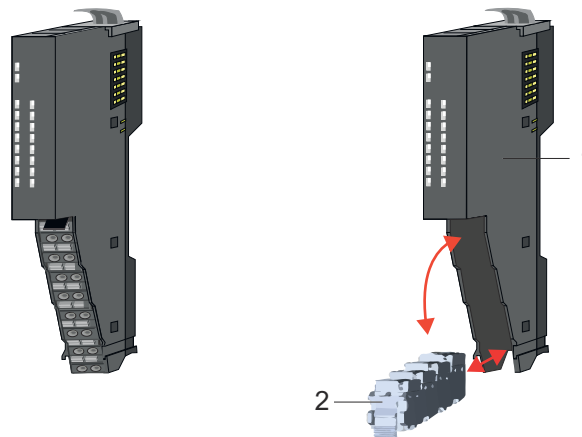

- 1 Electronic unit
- 2 Terminal block

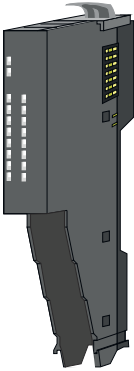
Electronic unit

The functionality of a 16x periphery module is defined via the terminal block, which is connected to the *electronic unit* via a secure flap mechanism. In the case of an error you can exchange the defective electronic unit for a functional unit with standing wiring. At the front side there are LEDs for status indication. For easy wiring each electronic unit shows corresponding connection information at the side. The electronic unit provides the slot for the terminal block for the wiring and contains the backplane bus with power supply for the electronic and the connection to the DC 24V power section supply. Additionally the electronic unit has a locking system for fixing it at a mounting rail. By means of this locking system your system may be assembled outside of your switchgear cabinet to be later mounted there as whole system.

Terminal block

The *terminal block* provides the electrical interface for the signalling and supplies lines of the module. When mounting the terminal block, it is attached to the bottom of the electronic unit and turned towards the electronic unit until it clicks into place. With the wiring a "push-in" spring-clip technique is used. This allows a quick and easy connection of your signal and supply lines. The clamping off takes place by means of a screwdriver.

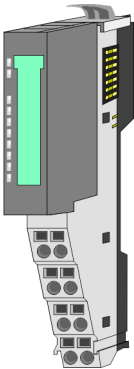
Power module

In the System SLIO the power supply is established by power modules. These are either integrated to the head module or may be installed between the periphery modules. Depending on the power module isolated areas of the DC 24V power section supply may be defined respectively the electronic power supply may be extended with 2A. For better recognition the colour of the power modules are contrasting to the periphery modules.

2.2.3 Accessories**Shield bus carrier**

Please note that a shield bus carrier cannot be mounted on a 16x periphery module!



The shield bus carrier (order no.: 000-0AB00) serves to carry the shield bus (10mm x 3mm) to connect cable shields. Shield bus carriers, shield bus and shield fixings are not in the scope of delivery. They are only available as accessories. The shield bus carrier is mounted underneath the terminal of the terminal module. With a flat mounting rail for adaptation to a flat mounting rail you may remove the spacer of the shield bus carrier.

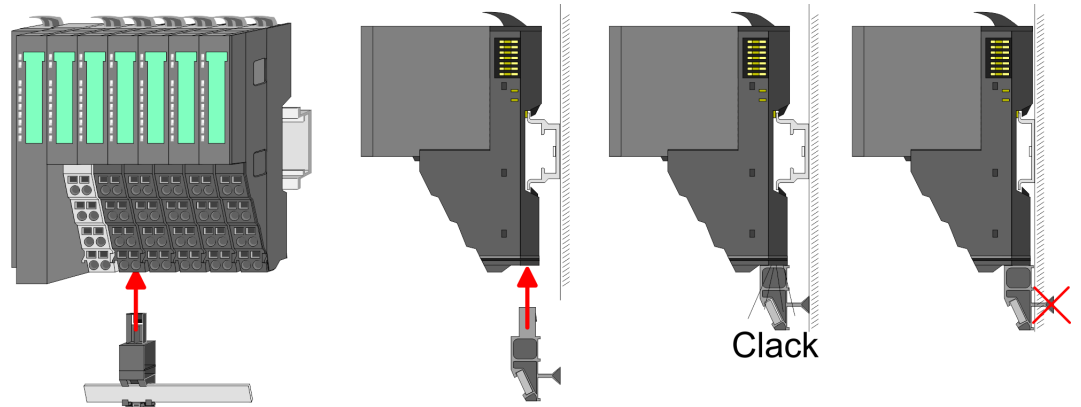

Bus cover

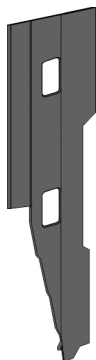

With each head module, to protect the backplane bus connectors, there is a mounted bus cover in the scope of delivery. You have to remove the bus cover of the head module before mounting a System SLIO module. For the protection of the backplane bus connector you always have to mount the bus cover at the last module of your system again. The bus cover has the order no. 000-0AA00.

Coding pins



Please note that a coding pin cannot be installed on a 16x periphery module! Here you have to make sure that the associated terminal block is plugged again when the electronics unit is replaced.

There is the possibility to fix the assignment of electronic and terminal module. Here coding pins (order number 000-0AC00) can be used. The coding pin consists of a coding jack and a coding plug. By combining electronic and terminal module with coding pin, the coding jack remains in the electronic module and the coding plug in the terminal module. This ensures that after replacing the electronic module just another electronic module can be plugged with the same encoding.

2.2.4 Hardware revision

Hardware revision on the front

- The hardware revision is printed on every System SLIO module.
- Since a System SLIO 8x peripheral module consists of a terminal and electronic module, you will find a hardware revision printed on each of them.
- Authoritative for the hardware revision of a System SLIO module is the hardware revision of the electronic module. This is located under the labeling strip of the corresponding electronic module.
- Depending on the module type, there are the following 2 variants e.g. to indicate hardware revision 1:
 - Current modules have a 1 on the front.
 - With earlier modules, the 1 is marked with 'X' on a number grid.

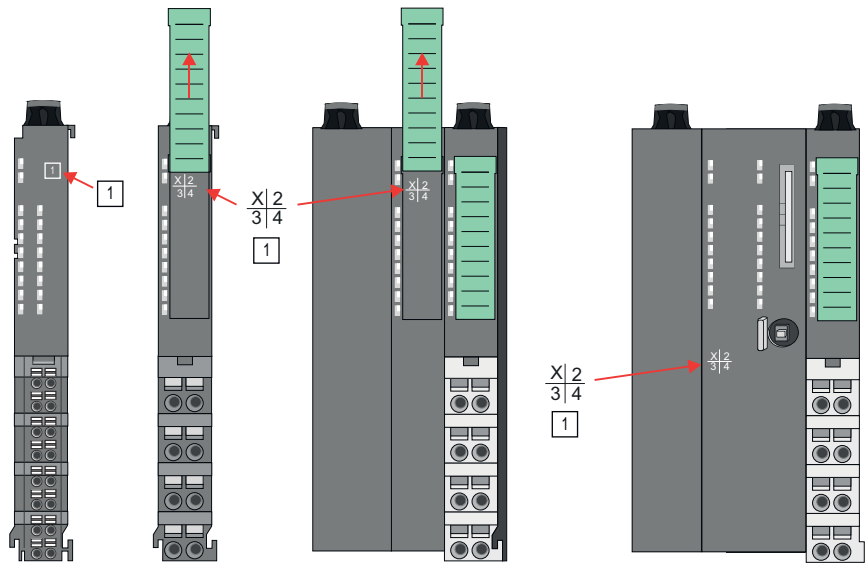

Hardware revision via web server

On the CPUs and some bus couplers, you can check the hardware revision 'HW Revision' via the integrated web server.

2.3 Dimensions

CPU 01xC

All dimensions are in mm.

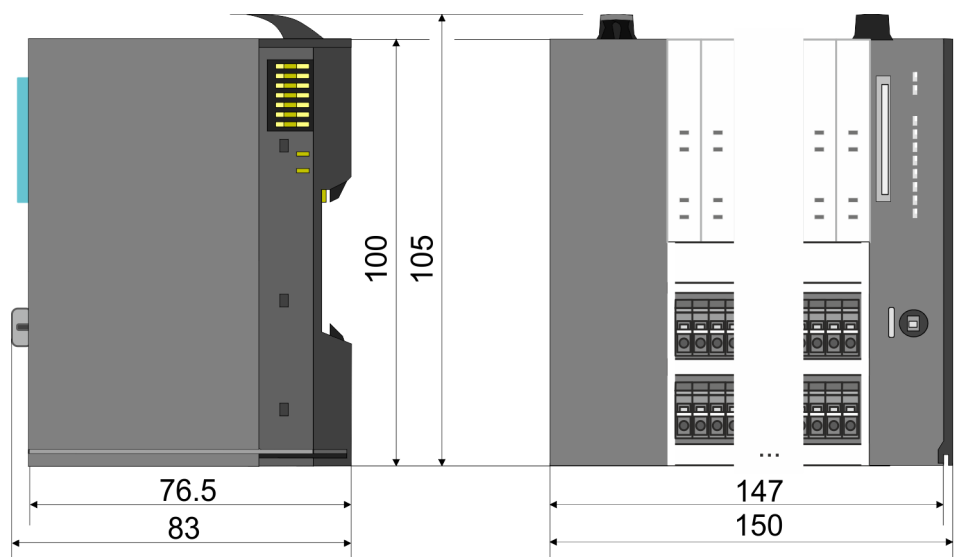

Dimensions

CPU 01x

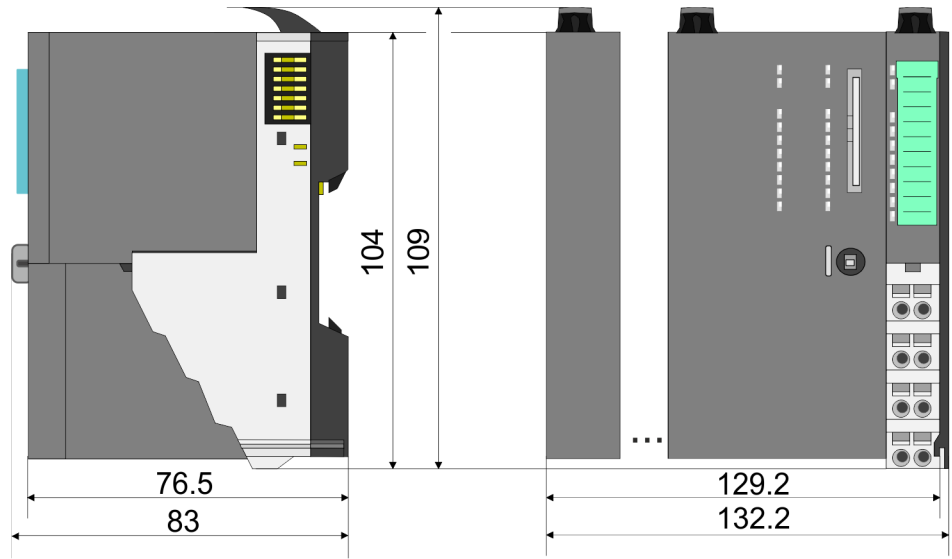

Bus coupler and line extension slave

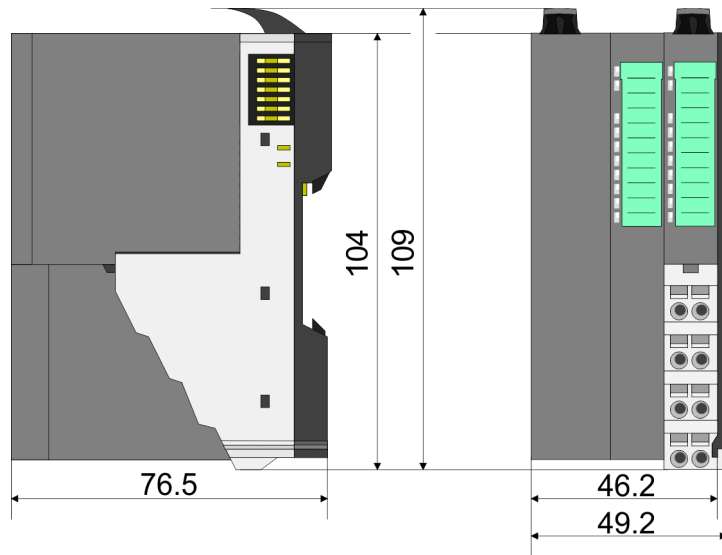

Line extension master

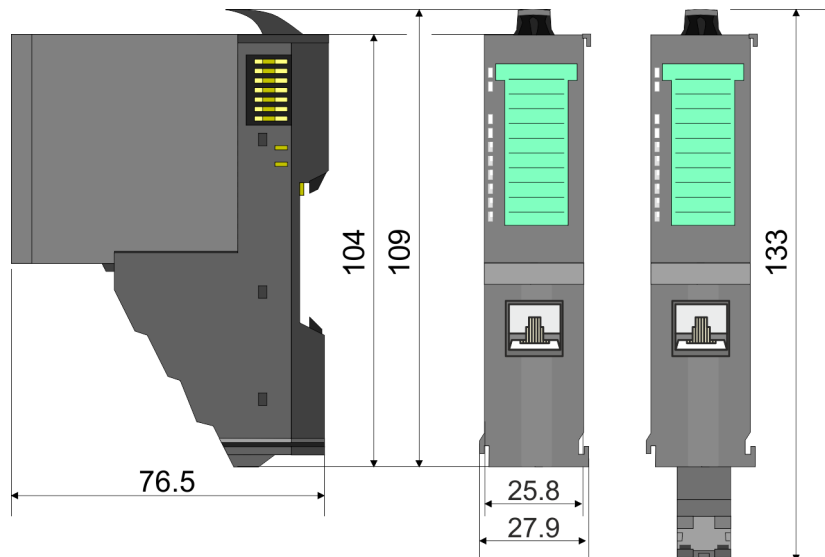

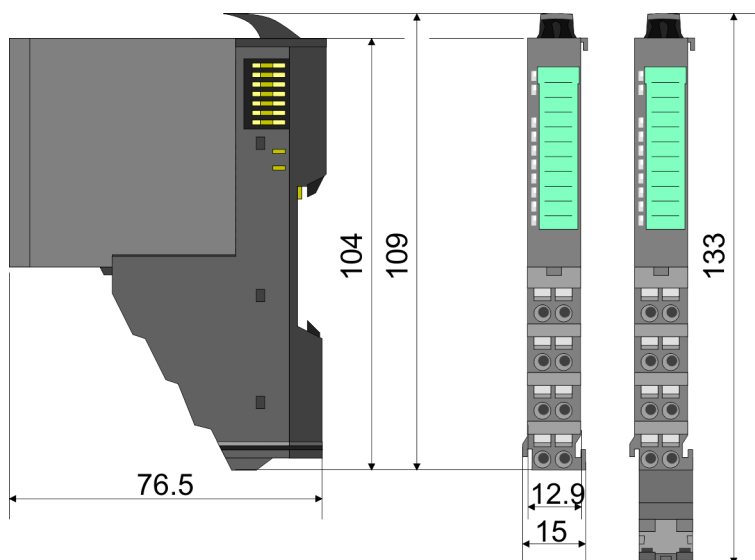
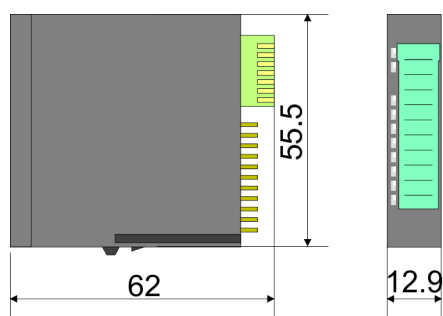
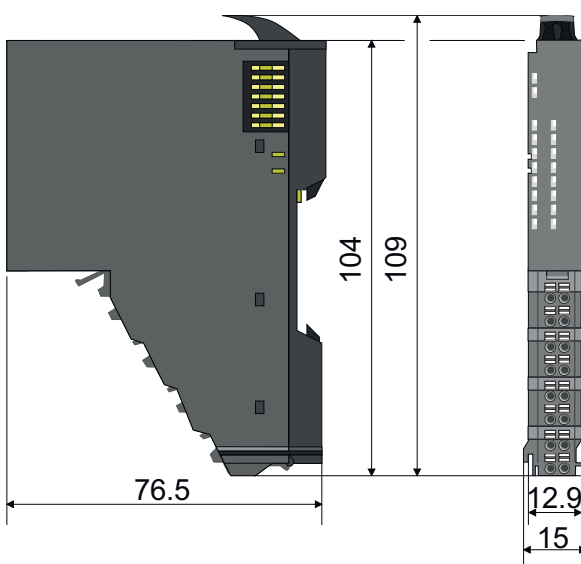
8x periphery module**Electronic module****16x periphery module**

2.4 Mounting bus coupler



CAUTION!

Requirements for UL compliance use

- Use for power supply exclusively SELV/PELV power supplies.
- The System SLIO must be installed and operated in a housing according to IEC 61010-1 9.3.2 c).

There are locking lever at the top side of the bus coupler. For mounting and demounting these locking lever are to be turned upwards until these engage. Place the bus coupler at the mounting rail. The bus coupler is fixed to the mounting rail by pushing downward the locking levers. The bus coupler is directly mounted at a mounting rail. Up to 64 modules may be mounted. The electronic and power section supply are connected via the back-plane bus. Please consider here that the sum current of the electronic power supply does not exceed the maximum value of 3A. By means of the power module 007-1AB10 the current of the electronic power supply may be expanded accordingly.

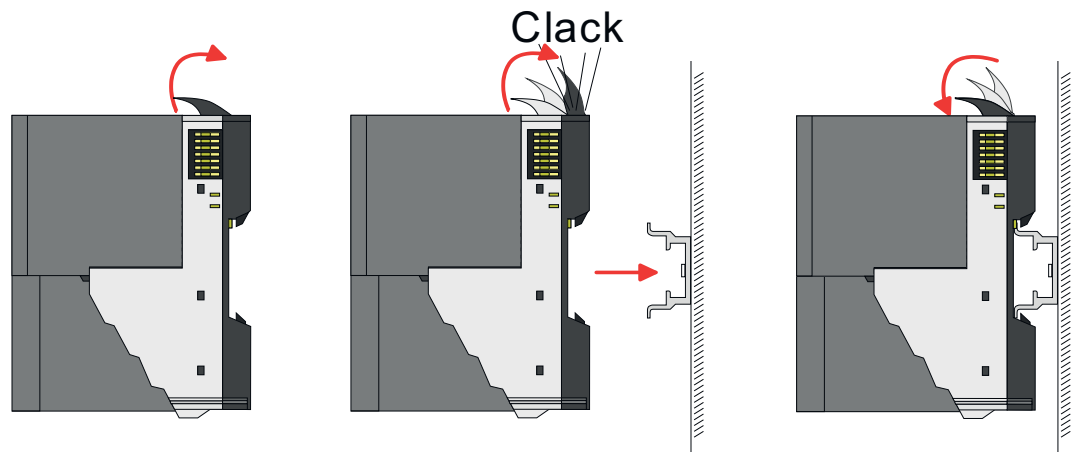

Proceeding

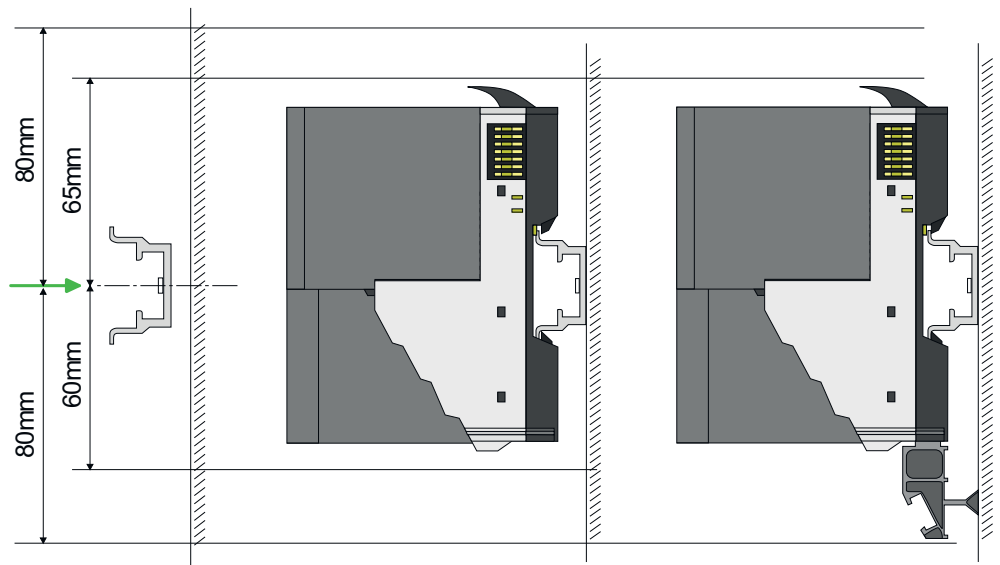

1. ➔ Mount the mounting rail! Please consider that a clearance from the middle of the mounting rail of at least 80mm above and 60mm below, respectively 80mm by deployment of shield bus carriers, exist.

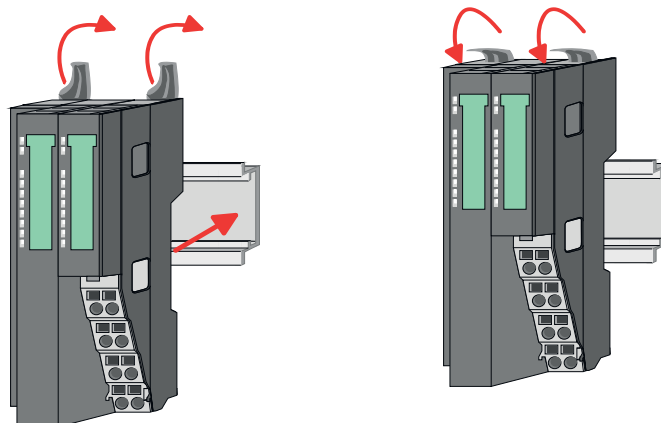

2. Turn the locking lever upwards, place the bus coupler at the mounting rail and turn the lever downward.

Mounting peripheral modules

The procedure is identical for 8x and 16x peripheral modules.

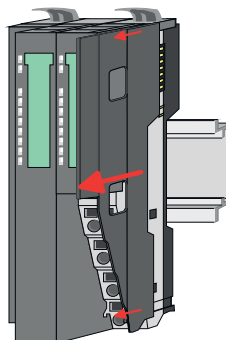

1. Before mounting the peripheral modules you have to remove the bus cover at the right side of the bus coupler by pulling it forward. Keep the cover for later mounting.

Clack

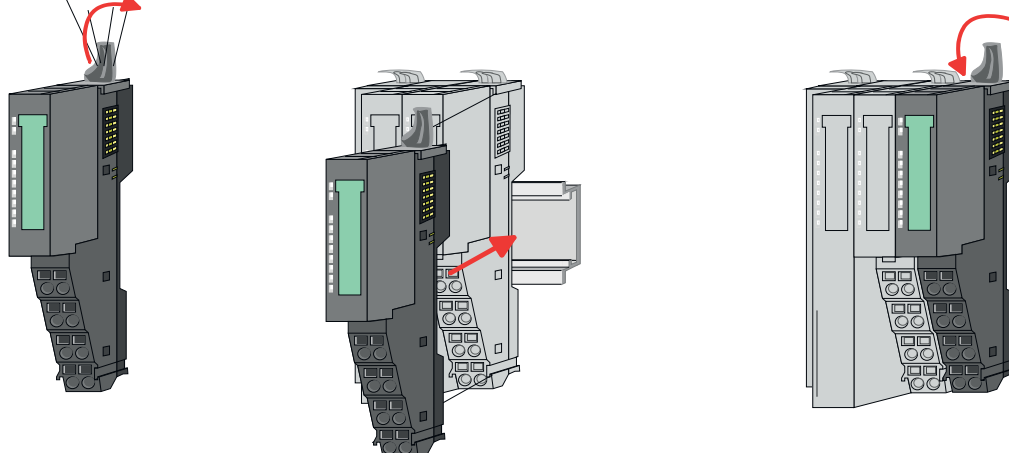

2. Mount the peripheral modules you want.

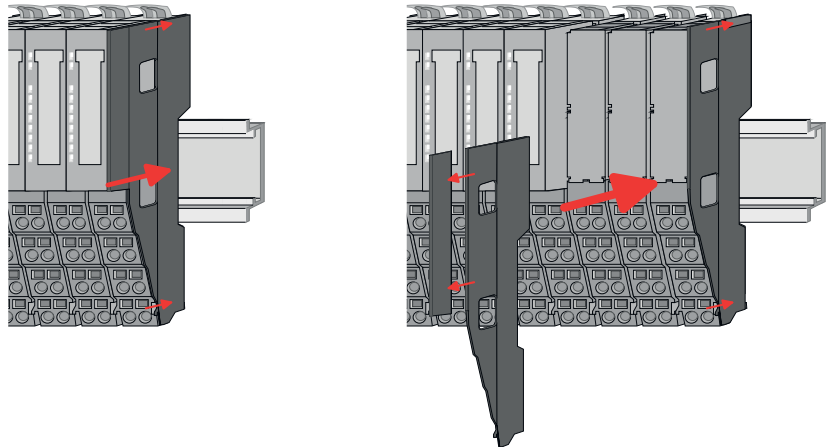

3. After mounting the whole system, to protect the backplane bus connectors at the last module you have to mount the bus cover, now. If the last module is a clamp module, for adaptation the upper part of the bus cover is to be removed.

2.5 Wiring



CAUTION!

Consider temperature for external cables!

Cables may experience temperature increase due to system heat dissipation. Thus the cabling specification must be chosen 5°C above ambient temperature!



CAUTION!

Separate insulation areas!

The system is specified for SELV/PELV environment. Devices, which are attached to the system must meet these specifications. Installation and cable routing other than SELV/PELV specification must be separated from the system's equipment!

2.5.1 Wiring bus coupler

Terminal module terminals

The System SLIO bus coupler have a power module integrated. Terminals with spring clamp technology are used for wiring. The spring clamp technology allows quick and easy connection of your signal and supply lines. In contrast to screw terminal connections this type of connection is vibration proof.

Data

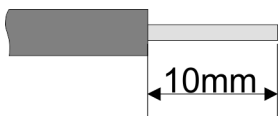

U_{max}	30V DC
I_{max}	10A
Cross section	0.08 ... 1.5mm ² (AWG 28 ... 16)
Stripping length	10mm

Wiring procedure

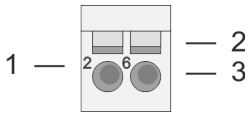

- 1 Pin number at the connector
- 2 Opening for screwdriver
- 3 Connection hole for wire

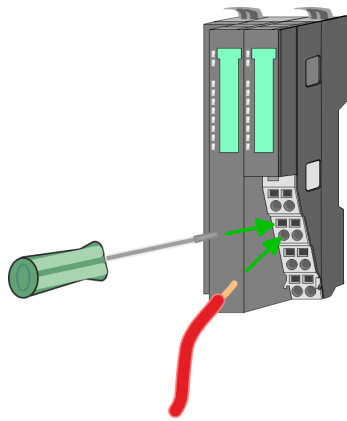
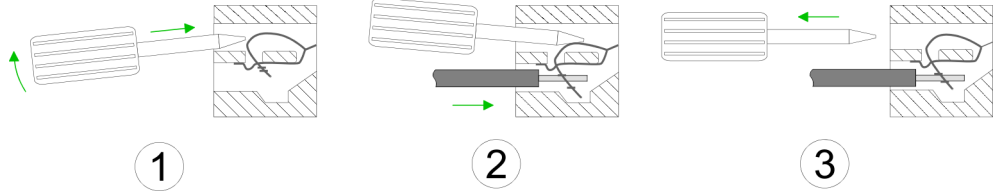

- 1. Insert a suited screwdriver at an angle into the square opening as shown. Press and hold the screwdriver in the opposite direction to open the contact spring.
- 2. Insert the stripped end of wire into the round opening. You can use wires with a cross section of 0.08mm² up to 1.5mm²
- 3. By removing the screwdriver, the wire is securely fixed via the spring contact to the terminal.

Standard wiring

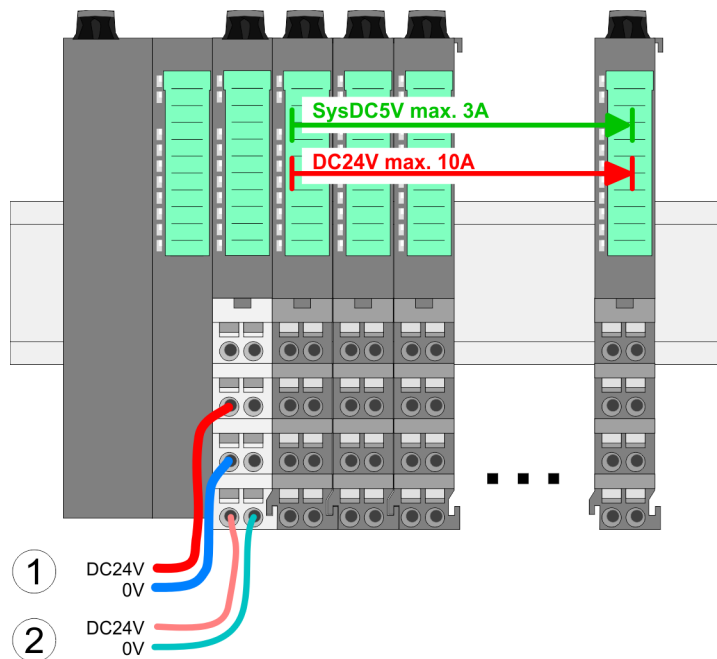

- (1) DC 24V for power section supply I/O area (max. 10A)
- (2) DC 24V for electronic power supply bus coupler and I/O area

PM - Power module

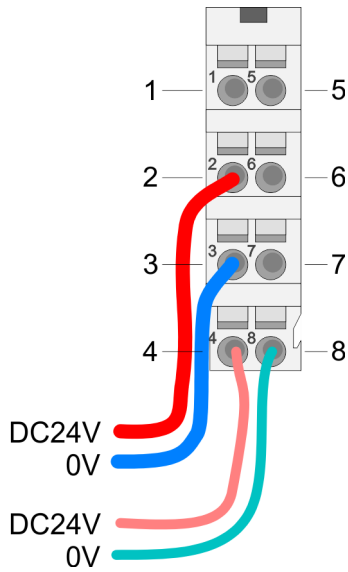

For wires with a core cross-section of 0.08mm² up to 1.5mm².

Pos.	Function	Type	Description
1	---	---	not connected
2	DC 24V	I	DC 24V for power section supply
3	0V	I	GND for power section supply
4	Sys DC 24V	I	DC 24V for electronic section supply
5	---	---	not connected
6	DC 24V	I	DC 24V for power section supply
7	0V	I	GND for power section supply
8	Sys 0V	I	GND for electronic section supply

I: Input



CAUTION!

Since the power section supply is not internally protected, it is to be externally protected with a fuse, which corresponds to the maximum current. This means max. 10A is to be protected by a 10A fuse (fast) respectively by a line circuit breaker 10A characteristics Z!



The electronic power section supply is internally protected against higher voltage by fuse. The fuse is within the power module. If the fuse releases, its electronic module must be exchanged!

Fusing

- The power section supply is to be externally protected with a fuse, which corresponds to the maximum current. This means max. 10A is to be protected with a 10A fuse (fast) respectively by a line circuit breaker 10A characteristics Z!
- It is recommended to externally protect the electronic power supply for bus coupler and I/O area with a 2A fuse (fast) respectively by a line circuit breaker 2A characteristics Z.
- The electronic power supply for the I/O area of the power module 007-1AB10 should also be externally protected with a 1A fuse (fast) respectively by a line circuit breaker 1A characteristics Z.

State of the electronic power supply via LEDs

After PowerON of the System SLIO the LEDs RUN respectively MF get on so far as the sum current does not exceed 3A. With a sum current greater than 3A the LEDs may not be activated. Here the power module with the order number 007-1AB10 is to be placed between the peripheral modules.

Shield attachment

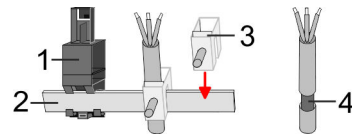

- 1 Shield bus carrier
- 2 Shield bus (10mm x 3mm)
- 3 Shield clamp
- 4 Cable shield

To attach the shield the mounting of shield bus carriers are necessary. The shield bus carrier (available as accessory) serves to carry the shield bus to connect cable shields.

1. ➤ Each System SLIO module has a carrier hole for the shield bus carrier. Push the shield bus carrier, until they engage into the module. With a flat mounting rail for adaptation to a flat mounting rail you may remove the spacer of the shield bus carrier.
2. ➤ Put your shield bus into the shield bus carrier.

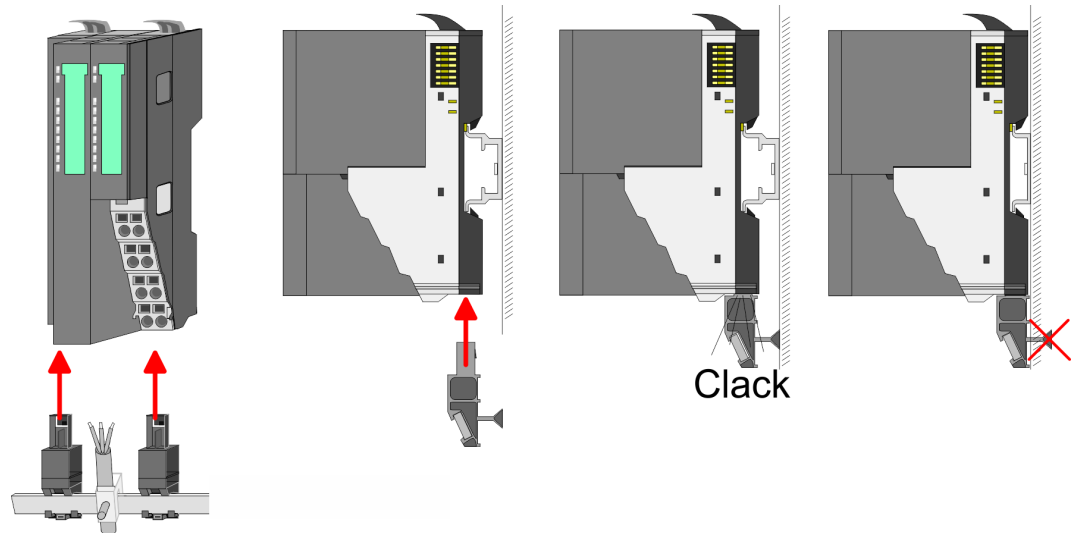

3. ➤ Attach the cables with the accordingly stripped cable screen and fix it by the shield clamp with the shield bus.

2.5.2 Wiring 8x periphery modules

Terminal module terminals

**CAUTION!****Do not connect hazardous voltages!**

If this is not explicitly stated in the corresponding module description, hazardous voltages are not allowed to be connected to the corresponding terminal module!

- With wiring the terminal modules, terminals with spring clamp technology are used for wiring. The spring clamp technology allows quick and easy connection of your signal and supply lines. In contrast to screw terminal connections this type of connection is vibration proof.

Data

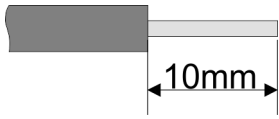

U_{max} 240V AC / 30V DC
 I_{max} 10A
 Cross section 0.08 ... 1.5mm² (AWG 28 ... 16)
 Stripping length 10mm

Wiring procedure

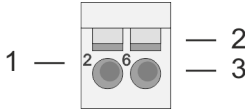

- 1 Pin number at the connector
- 2 Opening for screwdriver
- 3 Connection hole for wire

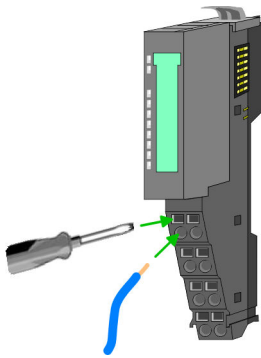
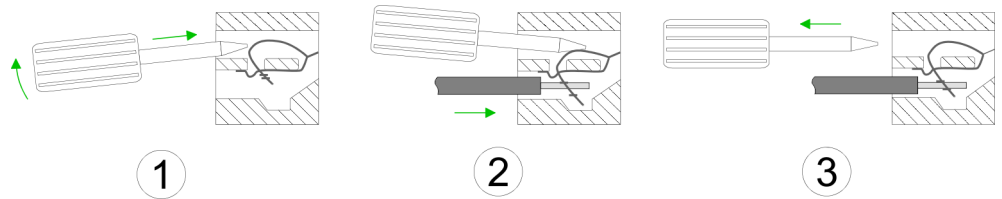

1. Insert a suited screwdriver at an angle into the square opening as shown. Press and hold the screwdriver in the opposite direction to open the contact spring.
2. Insert the stripped end of wire into the round opening. You can use wires with a cross section of 0.08mm² up to 1.5mm²
3. By removing the screwdriver, the wire is securely fixed via the spring contact to the terminal.

Shield attachment

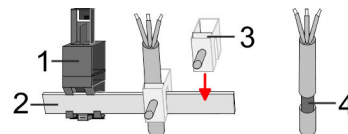

- 1 Shield bus carrier
- 2 Shield bus (10mm x 3mm)
- 3 Shield clamp
- 4 Cable shield

To attach the shield the mounting of shield bus carriers are necessary. The shield bus carrier (available as accessory) serves to carry the shield bus to connect cable shields.

1. Each System SLIO 8x periphery module has a carrier hole for the shield bus carrier. Push the shield bus carrier, until they engage into the module. With a flat mounting rail for adaptation to a flat mounting rail you may remove the spacer of the shield bus carrier.
2. Put your shield bus into the shield bus carrier.

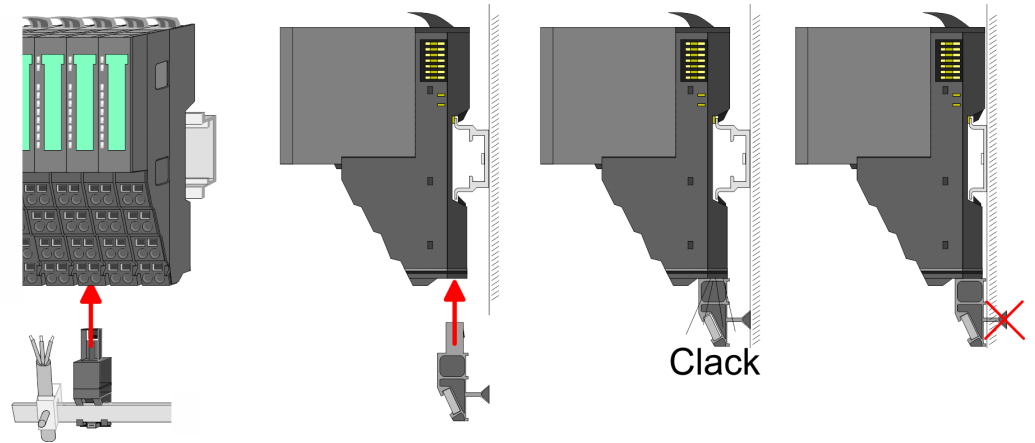

3. Attach the cables with the accordingly stripped cable screen and fix it by the shield clamp with the shield bus.

2.5.3 Wiring 16x periphery modules

Terminal block connectors



CAUTION!

Do not connect hazardous voltages!

If this is not explicitly stated in the corresponding module description, hazardous voltages are not allowed to be connected to the corresponding terminal block!

- The 16x periphery module has a removable terminal block for wiring.
- With the wiring of the terminal block a "push-in" spring-clip technique is used. This allows a quick and easy connection of your signal and supply lines.
- The clamping off takes place by means of a screwdriver.
- Please use copper wire only!

Data

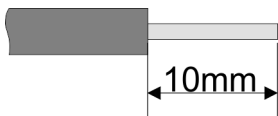

U_{max}	30V DC
I_{max}	10A
Cross section solid wire	0.25 ... 0.75mm ²
Cross section with ferrule	0.14 ... 0.75mm ²
Wire type	CU
AWG	24 ... 16
Stripping length	10mm

Wiring procedure



- 1 Release area
- 2 Connection hole for wire

Insert wire

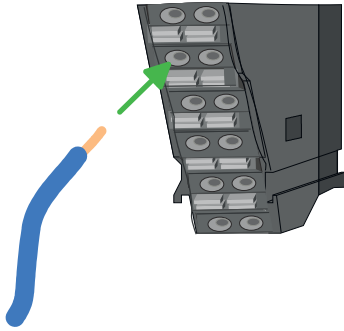

The wiring happens without a tool.

1. Determine according to the casing labelling the connection position.
2. Insert through the round connection hole of the according contact your prepared wire until it stops, so that it is fixed.
 - ⇒ By pushing the contact spring opens, thus ensuring the necessary contact pressure.

Remove wire

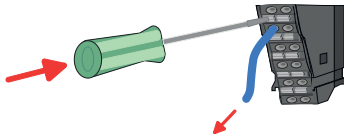

The wire is to be removed by means of a screwdriver with 2.5mm blade width.

1. Press with your screwdriver vertically at the release button.
 - ⇒ The contact spring releases the wire.
2. Pull the wire from the round hole.

2.5.4 Wiring power modules

Terminal module terminals

Power modules are either integrated to the head module or may be installed between the periphery modules. With power modules, terminals with spring clamp technology are used for wiring. The spring clamp technology allows quick and easy connection of your signal and supply lines. In contrast to screw terminal connections this type of connection is vibration proof.

Data

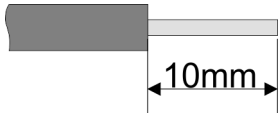

U_{max}	30V DC
I_{max}	10A
Cross section	0.08 ... 1.5mm ² (AWG 28 ... 16)
Stripping length	10mm

Wiring procedure

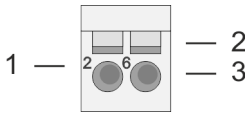

- 1 Pin number at the connector
- 2 Opening for screwdriver
- 3 Connection hole for wire

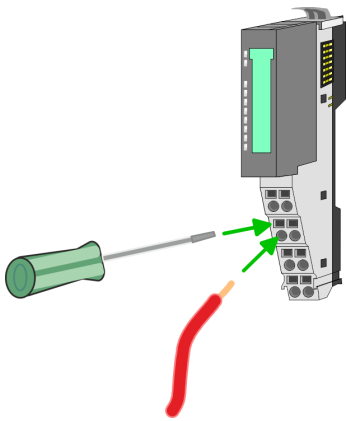
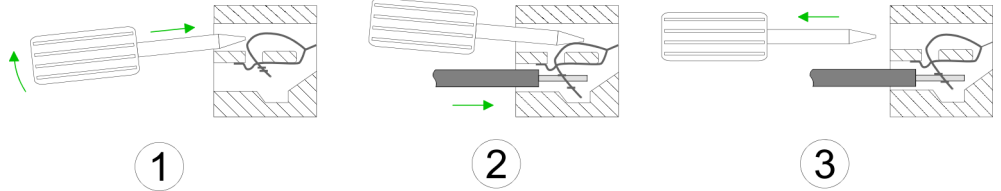

- 1. Insert a suited screwdriver at an angle into the square opening as shown. Press and hold the screwdriver in the opposite direction to open the contact spring.
- 2. Insert the stripped end of wire into the round opening. You can use wires with a cross section of 0.08mm² up to 1.5mm²
- 3. By removing the screwdriver, the wire is securely fixed via the spring contact to the terminal.

Standard wiring

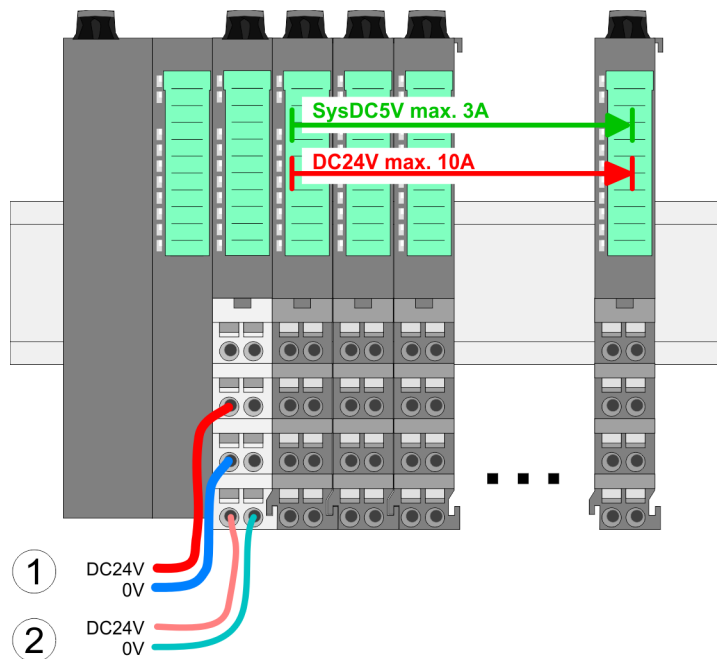

- (1) DC 24V for power section supply I/O area (max. 10A)
- (2) DC 24V for electronic power supply bus coupler and I/O area

PM - Power module

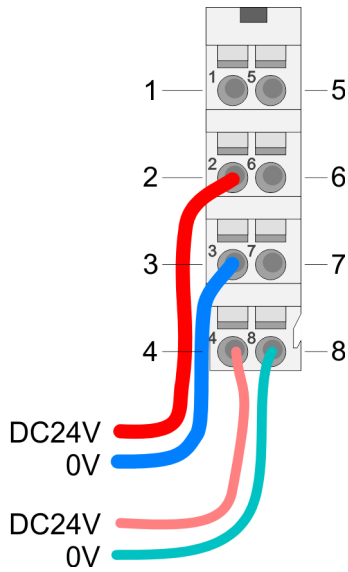

For wires with a core cross-section of 0.08mm² up to 1.5mm².

Pos.	Function	Type	Description
1	---	---	not connected
2	DC 24V	I	DC 24V for power section supply
3	0V	I	GND for power section supply
4	Sys DC 24V	I	DC 24V for electronic section supply
5	---	---	not connected
6	DC 24V	I	DC 24V for power section supply
7	0V	I	GND for power section supply
8	Sys 0V	I	GND for electronic section supply

I: Input



CAUTION!

Since the power section supply is not internally protected, it is to be externally protected with a fuse, which corresponds to the maximum current. This means max. 10A is to be protected by a 10A fuse (fast) respectively by a line circuit breaker 10A characteristics Z!



The electronic power section supply is internally protected against higher voltage by fuse. The fuse is within the power module. If the fuse releases, its electronic module must be exchanged!

Fusing

- The power section supply is to be externally protected with a fuse, which corresponds to the maximum current. This means max. 10A is to be protected with a 10A fuse (fast) respectively by a line circuit breaker 10A characteristics Z!
- It is recommended to externally protect the electronic power supply for head modules and I/O area with a 2A fuse (fast) respectively by a line circuit breaker 2A characteristics Z.
- The electronic power supply for the I/O area of the power module 007-1AB10 should also be externally protected with a 1A fuse (fast) respectively by a line circuit breaker 1A characteristics Z.

State of the electronic power supply via LEDs

After PowerON of the System SLIO the LEDs RUN respectively MF get on so far as the sum current does not exceed 3A. With a sum current greater than 3A the LEDs may not be activated. Here the power module with the order number 007-1AB10 is to be placed between the peripheral modules.

Deployment of the power modules

- If the 10A for the power section supply is no longer sufficient, you may use the power module with the order number 007-1AB00. So you have also the possibility to define isolated groups.
- The power module with the order number 007-1AB10 is to be used if the 3A for the electronic power supply at the backplane bus is no longer sufficient. Additionally you get an isolated group for the DC 24V power section supply with max. 4A.
- By placing the power module 007-1AB10 at the following backplane bus modules may be placed with a sum current of max. 2A. Afterwards a power module is to be placed again. To secure the power supply, the power modules may be mixed used.

Power module 007-1AB00

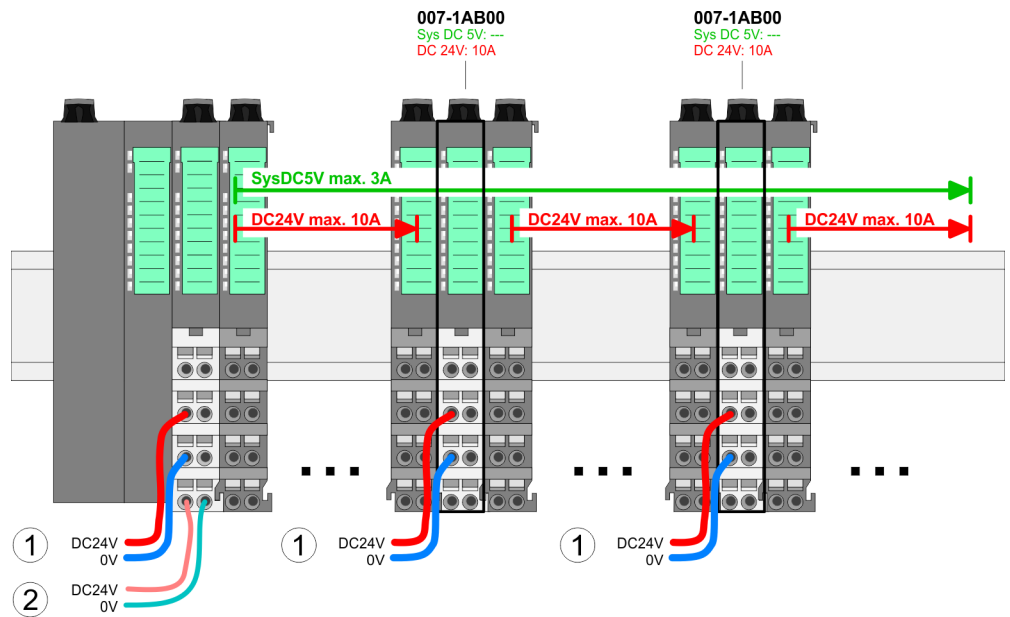

Power module 007-1AB10

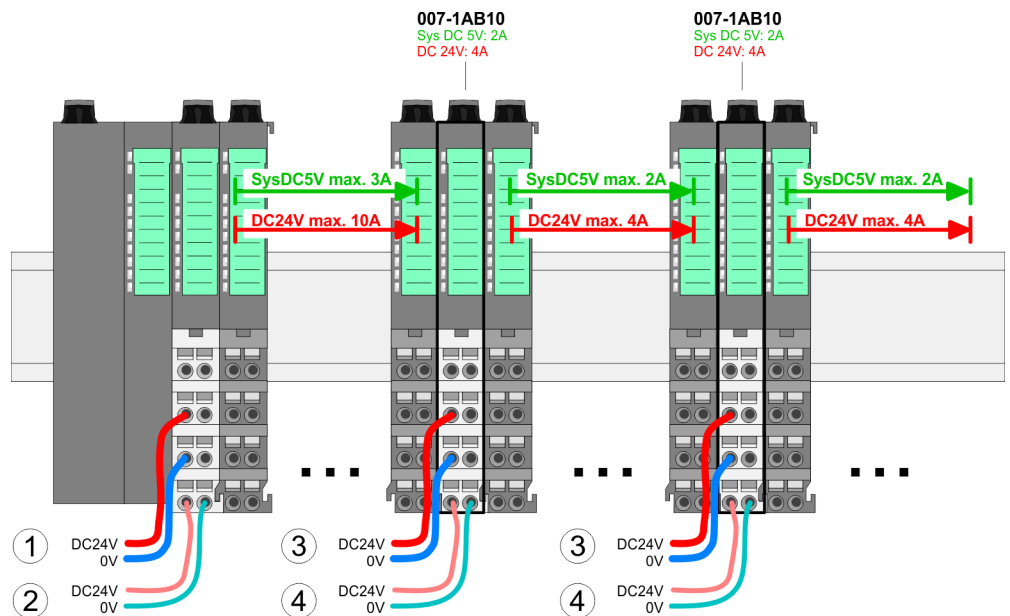

- (1) DC 24V for power section supply I/O area (max. 10A)
- (2) DC 24V for electronic power supply bus coupler and I/O area
- (3) DC 24V for power section supply I/O area (max. 4A)
- (4) DC 24V for electronic power supply I/O area

Shield attachment

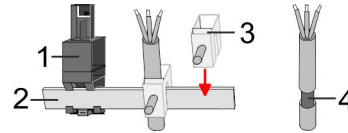

- 1 Shield bus carrier
- 2 Shield bus (10mm x 3mm)
- 3 Shield clamp
- 4 Cable shield

To attach the shield the mounting of shield bus carriers are necessary. The shield bus carrier (available as accessory) serves to carry the shield bus to connect cable shields.

- 1. ➤ Each System SLIO 8x peripheral module has a carrier hole for the shield bus carrier. Push the shield bus carrier, until they engage into the module. With a flat mounting rail for adaptation to a flat mounting rail you may remove the spacer of the shield bus carrier.
- 2. ➤ Put your shield bus into the shield bus carrier.

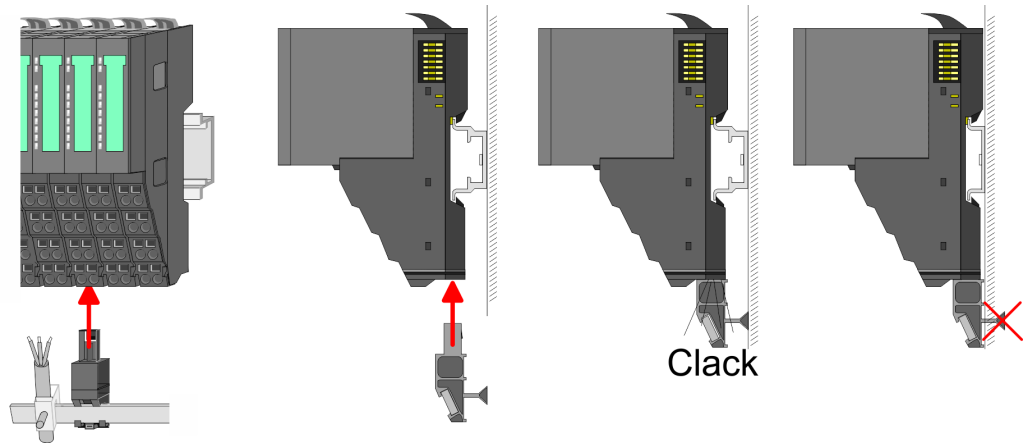

- 3. ➤ Attach the cables with the accordingly stripped cable screen and fix it by the shield clamp with the shield bus.

2.6 Demounting

2.6.1 Demounting bus coupler

Proceeding



CAUTION!

Bus interface and power module may not be separated! Here you may only exchange the electronic module!

- 1. ➤ Power-off your system.
- 2. ➤ Remove if exists the wiring of the bus coupler.

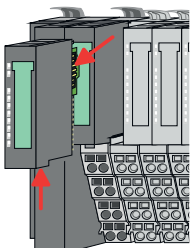

- 3. ➤



For demounting and exchange of a (head) module or a group of modules, due to mounting reasons you always have to remove the electronic module right beside. After mounting it may be plugged again.

Press the unlocking lever at the lower side of the just mounted right module near the bus coupler and pull it forward.

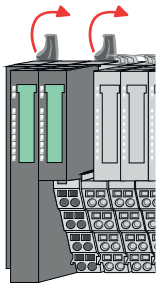

4. Turn all the locking lever of the bus coupler to be exchanged upwards.

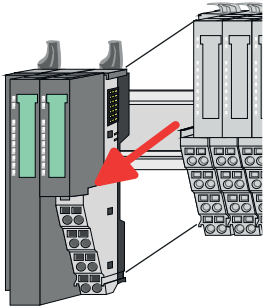

5. Pull the bus coupler forward.

6. For mounting turn all the locking lever of the bus coupler to be exchanged upwards.

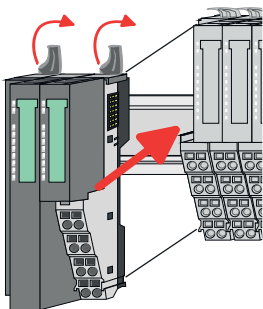

7. To mount the bus coupler put it to the left periphery module and push it, guided by the stripes, to the mounting rail.

8. Turn all the locking lever downward, again.

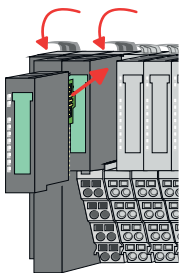

9. Plug again the electronic module, which you have removed before.

10. Wire your bus coupler.

⇒ Now you can bring your system back into operation.

2.6.2 Demounting 8x periphery modules

Proceeding

Exchange of an electronic module

1. ➤ Power-off your system.

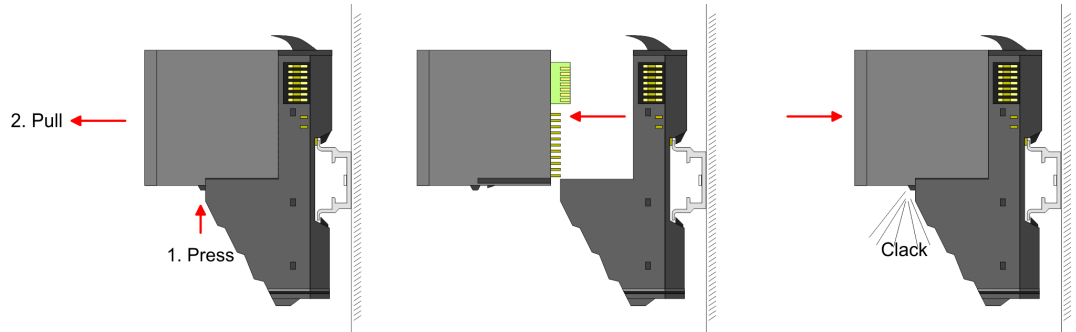

2. ➤ For the exchange of a electronic module, the electronic module may be pulled forward after pressing the unlocking lever at the lower side of the module.
3. ➤ For installation plug the new electronic module guided by the strips at the lower side until this engages to the terminal module.
 - ⇒ Now you can bring your system back into operation.



Easy Maintenance

'Easy Maintenance' means the support for adding and removing electronic modules during operation without having to restart the system. If this is supported by your head module, you will find more detailed information on this in the "Deployment" chapter. ↪ Chap. 4.7 'Easy Maintenance' page 78

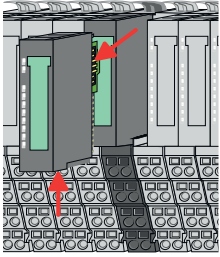
Exchange of a periphery module

1. ➤ Power-off your system.
2. ➤ Remove if exists the wiring of the module.
3. ➤



For demounting and exchange of a (head) module or a group of modules, due to mounting reasons you always have to remove the electronic module right beside. After mounting it may be plugged again.

Press the unlocking lever at the lower side of the just mounted right module and pull it forward.

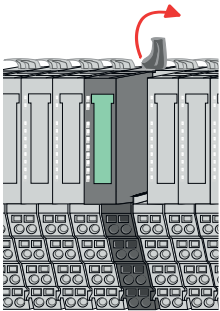

4. ➤ Turn the locking lever of the module to be exchanged upwards.

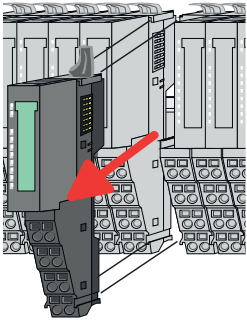

5. ➤ Pull the module.
6. ➤ For mounting turn the locking lever of the module to be mounted upwards.

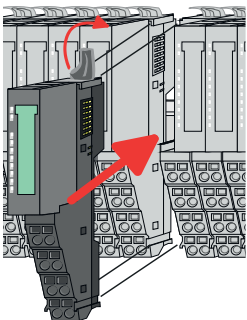

7. ➤ To mount the module put it to the gap between the both modules and push it, guided by the stripes at both sides, to the mounting rail.
8. ➤ Turn the locking lever downward, again.

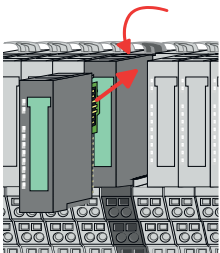

9. ➤ Plug again the electronic module, which you have removed before.
10. ➤ Wire your module.
 - ⇒ Now you can bring your system back into operation.

Exchange of a module group

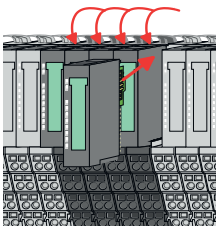
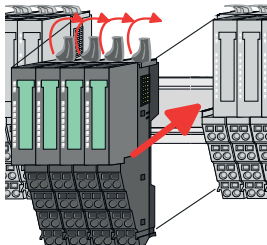
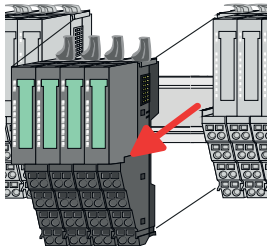
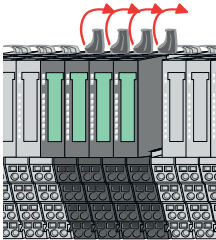
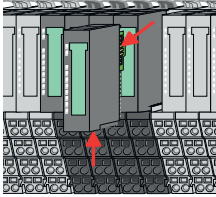

1. ➤ Power-off your system.
2. ➤ Remove if exists the wiring of the module group.

3. ➤  *For demounting and exchange of a (head) module or a group of modules, due to mounting reasons you always have to remove the electronic module right beside. After mounting it may be plugged again.*

Press the unlocking lever at the lower side of the just mounted right module near the module group and pull it forward.

4. ➤ Turn all the locking lever of the module group to be exchanged upwards.
5. ➤ Pull the module group forward.
6. ➤ For mounting turn all the locking lever of the module group to be mounted upwards.

7. ➤ To mount the module group put it to the gap between the both modules and push it, guided by the stripes at both sides, to the mounting rail.
8. ➤ Turn all the locking lever downward, again.

9. ➤ Plug again the electronic module, which you have removed before.
10. ➤ Wire your module group.
⇒ Now you can bring your system back into operation.

2.6.3 Demounting 16x periphery modules

Proceeding

Exchange of an electronic unit

1. ➤ Power-off your system.
2. ➤ To replace an electronic unit, you can push down and pull off the terminal block after releasing the lock.

To mount the terminal block, place it horizontally on the lower side of the electronic unit and push it towards the electronic unit until it clicks into place.

⇒ Now you can bring your system back into operation.

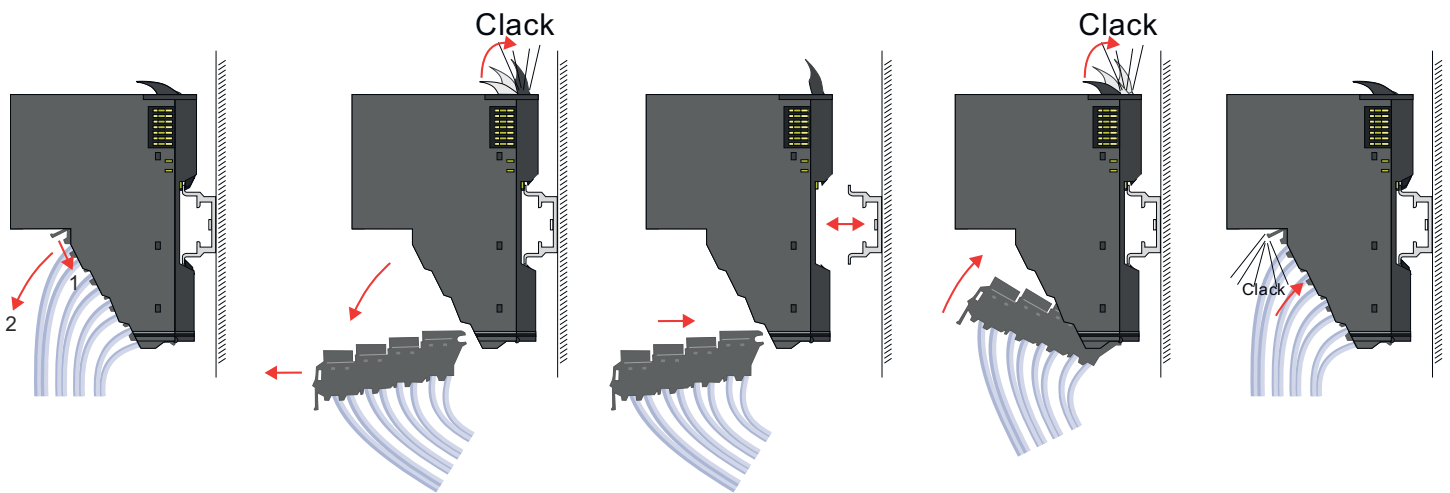

Exchange of a 16x periphery module

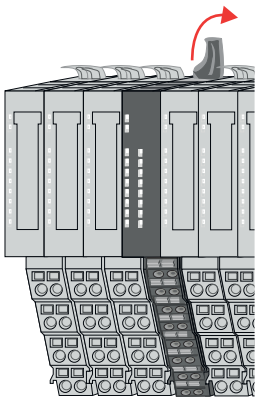

1. ➤ Power-off your system.
2. ➤ Remove if exists the wiring of the module respectively the wired terminal block.
3. ➤



In contrast to 8x periphery modules, you can directly demount and mount 16x periphery modules.

Turn the locking lever of the module to be exchanged upwards.

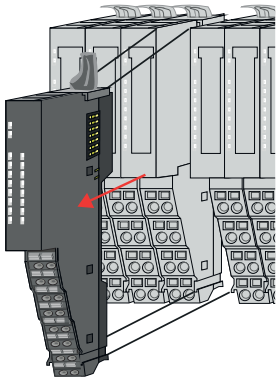

4. ➤ Pull the module.
5. ➤ For mounting turn the locking lever of the module to be mounted upwards.

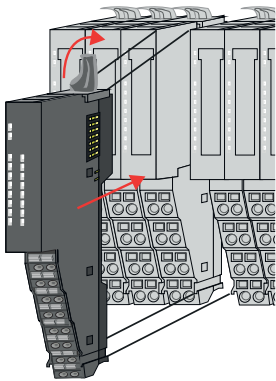

6. ➤ To mount the module put it to the gap between the both modules and push it, guided by the stripes at both sides, to the mounting rail.

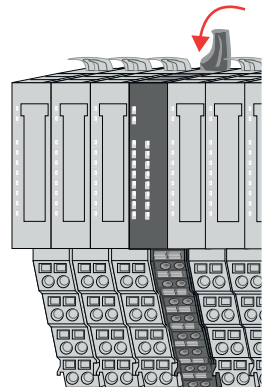

7. ➤ Turn the locking lever downward, again.
8. ➤ Wire your module respectively plug the wired terminal block again.
 - ⇒ Now you can bring your system back into operation.

Exchange of a module group

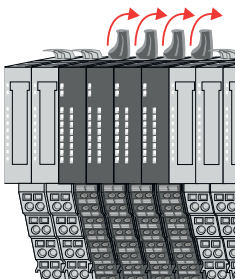

1. ➤ Power-off your system.
2. ➤ Remove if exists the wiring of the module group respectively the wired terminal blocks.
3. ➤

i *In contrast to 8x periphery modules, you can directly demount and mount 16x periphery modules.*

Turn all the locking lever of the module group to be exchanged upwards.

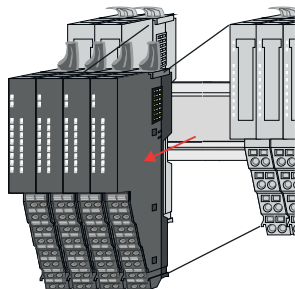

4. ➤ Pull the module group forward.
5. ➤ For mounting turn all the locking lever of the module group to be mounted upwards.

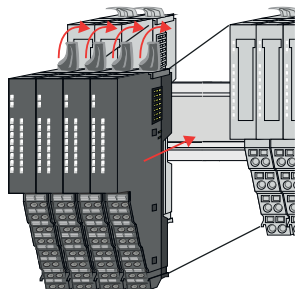

6. ➤ To mount the module group put it to the gap between the both modules and push it, guided by the stripes at both sides, to the mounting rail.

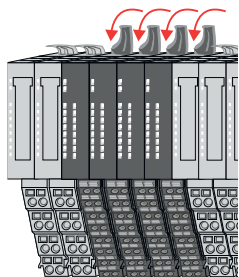

7. ➤ Turn all the locking lever downward, again.
8. ➤ Wire your module group respectively plug the wired terminal blocks again.
⇒ Now you can bring your system back into operation.

2.7 Trouble shooting - LEDs

General

Each module has the LEDs RUN and MF on its front side. Errors or incorrect modules may be located by means of these LEDs.

In the following illustrations flashing LEDs are marked by ☼.

Sum current of the electronic power supply exceeded

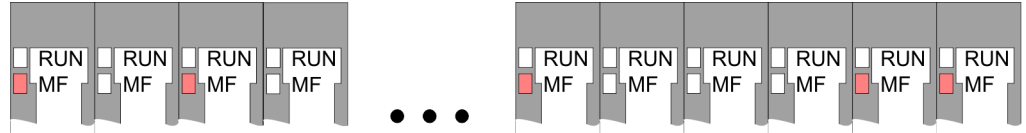

Behaviour: After PowerON the RUN LED of each module is off and the MF LED of each module is sporadically on.

Reason: The maximum current for the electronic power supply is exceeded.

Remedy: As soon as the sum current of the electronic power supply is exceeded, always place the power module 007-1AB10. ↪ Chap. 2.5.4 'Wiring power modules' page 26

Error in configuration

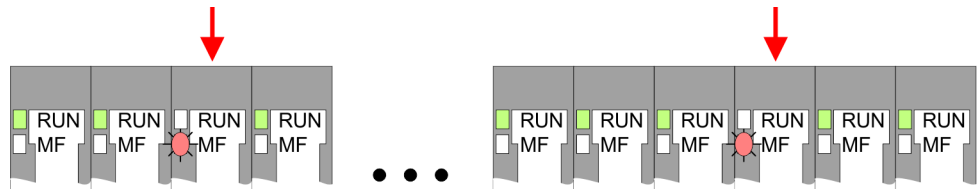

Behaviour: After PowerON the MF LED of one module respectively more modules flashes. The RUN LED remains off.

Reason: At this position a module is placed, which does not correspond to the configured module.

Remedy: Match configuration and hardware structure.

Module failure

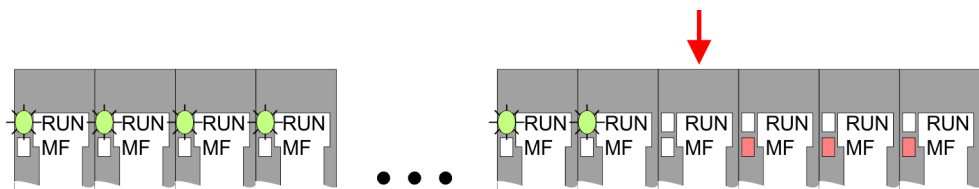

Behaviour: After PowerON all of the RUN LEDs up to the defective module are flashing. With all following modules the MF LED is on and the RUN LED is off.

Reason: The module on the right of the flashing modules is defective.

Remedy: Replace the defective module.

2.8 Industrial security and installation guidelines

2.8.1 Industrial security in information technology

Latest version

This chapter can also be found as a guide '*Industrial IT Security*' at www.yaskawa.eu.com

Hazards

The topic of data security and access protection has become increasingly important in the industrial environment. The increased networking of entire industrial systems to the network levels within the company together with the functions of remote maintenance have all served to increase vulnerability. Hazards can arise from:

- Internal manipulation such as technical errors, operating and program errors and deliberate program or data manipulation.
- External manipulation such as software viruses, worms and Trojans.
- Human carelessness such as password phishing.

Precautions

The most important precautions to prevent manipulation and loss of data security in the industrial environment are:

- Encrypting the data traffic by means of certificates.
- Filtering and inspection of the traffic by means of VPN - "Virtual Private Networks".
- Identification of the user by "Authentication" via safe channels.
- Segmenting in protected automation cells, so that only devices in the same group can exchange data.
- Deactivation of unnecessary hardware and software.

Further Information

You can find more information about the measures on the following websites:

- Federal Office for Information Technology www.bsi.bund.de
- Cybersecurity & Infrastructure Security Agency us-cert.cisa.gov
- VDI / VDE Society for Measurement and Automation Technology www.vdi.de

2.8.1.1 Protection of hardware and applications

Precautions

- Do not integrate any components or systems into public networks.
 - Use VPN "Virtual Private Networks" for use in public networks. This allows you to control and filter the data traffic accordingly.
- Always keep your system up-to-date.
 - Always use the latest firmware version for all devices.
 - Update your user software regularly.
- Protect your systems with a firewall.
 - The firewall protects your infrastructure internally and externally.
 - This allows you to segment your network and isolate entire areas.
- Secure access to your plants via user accounts.
 - If possible, use a central user management system.
 - Create a user account for each user for whom authorization is essential.
 - Always keep user accounts up-to-date and deactivate unused user accounts.
- Secure access to your plants via secure passwords.
 - Change the password of a standard login after the first start.
 - Use strong passwords consisting of upper/lower case, numbers and special characters. The use of a password generator or manager is recommended.
 - Change the passwords according to the rules and guidelines that apply to your application.
- Deactivate inactive communication ports respectively protocols.
 - Only the communication ports that are used for communication should be activated.
 - Only the communication protocols that are used for communication should be activated.
- Consider possible defence strategies when planning and securing the system.
 - The isolation of components alone is not sufficient for comprehensive protection. An overall concept is to be drawn up here, which also provides defensive measures in the event of a cyber attack.
 - Periodically carry out threat assessments. Among others, a comparison is made here between the protective measures taken and those required.
- Limit the use of external storage media.
 - Via external storage media such as USB memory sticks or SD memory cards, malware can get directly into a system while bypassing a firewall.
 - External storage media or their slots must be protected against unauthorized physical access, e.g. by using a lockable control cabinet.
 - Make sure that only authorized persons have access.
 - When disposing of storage media, make sure that they are safely destroyed.
- Use secure access paths such as HTTPS or VPN for remote access to your plant.
- Enable security-related event logging in accordance with the applicable security policy and legal requirements for data protection.

2.8.1.2 Protection of PC-based software

Precautions

Since PC-based software is used for programming, configuration and monitoring, it can also be used to manipulate entire systems or individual components. Particular caution is required here!

- Use user accounts on your PC systems.
 - If possible, use a central user management system.
 - Create a user account for each user for whom authorization is essential.
 - Always keep user accounts up-to-date and deactivate unused user accounts.
- Protect your PC systems with secure passwords.
 - Change the password of a standard login after the first start.
 - Use strong passwords consisting of upper/lower case, numbers and special characters. The use of a password generator or manager is recommended.
 - Change the passwords according to the rules and guidelines that apply to your application.
- Enable security-related event logging in accordance with the applicable security policy and legal requirements for data protection.
- Protect your PC systems by security software.
 - Install virus scanners on your PC systems to identify viruses, trojans and other malware.
 - Install software that can detect phishing attacks and actively prevent them.
- Always keep your software up-to-date.
 - Update your operating system regularly.
 - Update your software regularly.
- Make regular backups and store the media at a safe place.
- Regularly restart your PC systems. Only boot from storage media that are protected against manipulation.
- Use encryption systems on your storage media.
- Perform security assessments regularly to reduce the risk of manipulation.
- Use only data and software from approved sources.
- Uninstall software which is not used.
- Disable unused services.
- Activate a password-protected screen lock on your PC systems.
- Always lock your PC systems as soon as you leave your PC workstation.
- Do not click any links that come from unknown sources. If necessary ask, e.g. on e-mails.
- Use secure access paths such as HTTPS or VPN for remote access to your PC system.

2.8.2 Installation guidelines

General

The installation guidelines contain information about the interference free deployment of a PLC system. There is the description of the ways, interference may occur in your PLC, how you can make sure the electromagnetic compatibility (EMC), and how you manage the isolation.

What does EMC mean?

Electromagnetic compatibility (EMC) means the ability of an electrical device, to function error free in an electromagnetic environment without being interfered respectively without interfering the environment.

The components are developed for the deployment in industrial environments and meets high demands on the EMC. Nevertheless you should project an EMC planning before installing the components and take conceivable interference causes into account.

Possible interference causes

Electromagnetic interferences may interfere your control via different ways:

- Electromagnetic fields (RF coupling)
- Magnetic fields with power frequency
- Bus system
- Power supply
- Protected earth conductor

Depending on the spreading medium (lead bound or lead free) and the distance to the interference cause, interferences to your control occur by means of different coupling mechanisms.

There are:

- galvanic coupling
- capacitive coupling
- inductive coupling
- radiant coupling

Basic rules for EMC

In the most times it is enough to take care of some elementary rules to guarantee the EMC. Please regard the following basic rules when installing your PLC.

- Take care of a correct area-wide grounding of the inactive metal parts when installing your components.
 - Install a central connection between the ground and the protected earth conductor system.
 - Connect all inactive metal extensive and impedance-low.
 - Please try not to use aluminium parts. Aluminium is easily oxidizing and is therefore less suitable for grounding.
- When cabling, take care of the correct line routing.
 - Organize your cabling in line groups (high voltage, current supply, signal and data lines).
 - Always lay your high voltage lines and signal respectively data lines in separate channels or bundles.
 - Route the signal and data lines as near as possible beside ground areas (e.g. suspension bars, metal rails, tin cabinet).
- Proof the correct fixing of the lead isolation.
 - Data lines must be shielded.
 - Analog lines must be shielded. When transmitting signals with small amplitudes the one sided laying of the isolation may be favourable.
 - Cables for frequency inverters, servo and stepper motors must be shielded.
 - Lay the line isolation extensively on an isolation/protected earth conductor rail directly after the cabinet entry and fix the isolation with cable clamps.
 - Make sure that the isolation/protected earth conductor rail is connected impedance-low with the cabinet.
 - Use metallic or metallised plug cases for isolated data lines.
- In special use cases you should appoint special EMC actions.
 - Consider to wire all inductivities with erase links.
 - Please consider luminescent lamps can influence signal lines.
- Create a homogeneous reference potential and ground all electrical operating supplies when possible.
 - Please take care for the targeted employment of the grounding actions. The grounding of the PLC serves for protection and functionality activity.
 - Connect installation parts and cabinets with your PLC in star topology with the isolation/protected earth conductor system. So you avoid ground loops.
 - If there are potential differences between installation parts and cabinets, lay sufficiently dimensioned potential compensation lines.

Isolation of conductors

Electrical, magnetically and electromagnetic interference fields are weakened by means of an isolation, one talks of absorption. Via the isolation rail, that is connected conductive with the rack, interference currents are shunt via cable isolation to the ground. Here you have to make sure, that the connection to the protected earth conductor is impedance-low, because otherwise the interference currents may appear as interference cause.

When isolating cables you have to regard the following:

- If possible, use only cables with isolation tangle.
- The hiding power of the isolation should be higher than 80%.
- Normally you should always lay the isolation of cables on both sides. Only by means of the both-sided connection of the isolation you achieve high quality interference suppression in the higher frequency area. Only as exception you may also lay the isolation one-sided. Then you only achieve the absorption of the lower frequencies. A one-sided isolation connection may be convenient, if:
 - the conduction of a potential compensating line is not possible.
 - analog signals (some mV respectively μA) are transferred.
 - foil isolations (static isolations) are used.
- With data lines always use metallic or metallised plugs for serial couplings. Fix the isolation of the data line at the plug rack. Do not lay the isolation on the PIN 1 of the plug bar!
- At stationary operation it is convenient to strip the insulated cable interruption free and lay it on the isolation/protected earth conductor line.
- To fix the isolation tangles use cable clamps out of metal. The clamps must clasp the isolation extensively and have well contact.
- Lay the isolation on an isolation rail directly after the entry of the cable in the cabinet. Lead the isolation further on to your PLC and don't lay it on there again!

**CAUTION!****Please regard at installation!**

At potential differences between the grounding points, there may be a compensation current via the isolation connected at both sides.

Remedy: Potential compensation line

2.9 General data for the System SLIO**Conformity and approval**

Conformity		
CE	2014/35/EU	Low-voltage directive
	2014/30/EU	EMC directive
Approval		
UL	-	Refer to Technical data
Others		
RoHS	2011/65/EU	Restriction of the use of certain hazardous substances in electrical and electronic equipment

General data for the System SLIO

Protection of persons and device protection

Type of protection	-	IP20
Electrical isolation		
to the field bus	-	electrically isolated
to the process level	-	electrically isolated
Insulation resistance	-	-
Insulation voltage to reference earth		
Inputs / outputs	-	AC / DC 50V, test voltage AC 500V
Protective measures	-	against short circuit

Environmental conditions to EN 61131-2

Climatic		
Storage / transport	EN 60068-2-14	-25...+70°C
Operation		
Horizontal installation hanging	EN 61131-2	0...+60°C
Horizontal installation lying	EN 61131-2	0...+55°C
Vertical installation	EN 61131-2	0...+50°C
Air humidity	EN 60068-2-30	RH1 (without condensation, rel. humidity 10...95%)
Pollution	EN 61131-2	Degree of pollution 2
Installation altitude max.	-	2000m
Mechanical		
Oscillation	EN 60068-2-6	1g, 9Hz ... 150Hz
Shock	EN 60068-2-27	15g, 11ms

Mounting conditions

Mounting place	-	In the control cabinet
Mounting position	-	Horizontal and vertical

EMC	Standard	Comment	
Emitted interference	EN 61000-6-4	Class A (Industrial area)	
Noise immunity zone B	EN 61000-6-2	Industrial area	
		EN 61000-4-2	ESD 8kV at air discharge (degree of severity 3), 4kV at contact discharge (degree of severity 2)
		EN 61000-4-3	HF field immunity (casing) 80MHz ... 1000MHz, 10V/m, 80% AM (1kHz) 1.4GHz ... 2.0GHz, 3V/m, 80% AM (1kHz) 2GHz ... 2.7GHz, 1V/m, 80% AM (1kHz)
		EN 61000-4-6	HF conducted 150kHz ... 80MHz, 10V, 80% AM (1kHz)
		EN 61000-4-4	Burst, degree of severity 3
	EN 61000-4-5	Surge, degree of severity 3 ¹	

1) Due to the high-energetic single pulses with Surge an appropriate external protective circuit with lightning protection elements like conductors for lightning and overvoltage is necessary.

2.9.1 Use in difficult operating conditions



Without additional protective measures, the products must not be used in locations with difficult operating conditions; e.g. due to:

- *dust generation*
- *chemically active substances (corrosive vapors or gases)*
- *strong electric or magnetic fields*

2.10 System SLIO product variants for extended application range

The System SLIO product variants listed below only differ from the basic modules only in the extended temperature range and the use under condensation. All other data correspond to those of the basic modules. Information on structure and configuration can be found in the manuals for the basic modules in the 'Download Center' of www.yaskawa.eu.com



Please note that the product variants listed here may only be operated in combination with one another on the backplane bus! Mixed operation is not possible!

Basic modules	Product variants	Description
053-1PN01	053-1PN01-C	IM - 053-1PN01 - interface module PROFINET
021-1BF00	021-1BF00-C	SM 021 - digital input - 8xDI - DC 24V
022-1BF00	022-1BF00-C	SM 022 - digital output - 8xDO - DC 24V 0.5A
031-1CD30	031-1CD30-C	SM 031 - analog input - 4xAI - 16bit 0 ... 10V
031-1BD80	031-1BD80-C	SM 031 - analog input - 4xAI - 16bit R/RTD
032-1CD30	032-1CD30-C	SM 032 - analog output - 4xAI - 16bit 0 ... 10V

Environmental conditions according to EN 61131-2 for System SLIO basic modules

Climatic

Storage / transport	EN 60068-2-14	-25...+70°C
---------------------	---------------	-------------

Operation

Horizontal installation hanging	EN 61131-2	0...+60°C
Horizontal installation lying	EN 61131-2	0...+55°C
Vertical installation	EN 61131-2	0...+50°C
Air humidity	EN 60068-2-30	RH1 (without condensation, rel. humidity 10...95%)
Pollution	EN 61131-2	Degree of pollution 2

Environmental conditions according to EN 61131-2 for System SLIO product variants

Climatic

Storage / transport	EN 60068-2-14	-25...+70°C
---------------------	---------------	-------------

Operation

Horizontal installation hanging	EN 61131-2	-25 ... + 60 ° C
Horizontal installation lying	EN 61131-2	-25...+55°C
Vertical installation	EN 61131-2	-25 ... + 50 ° C
Air humidity	EN 60068-2-30	RH1 (without condensation, rel. humidity 10...95%)
Climate	GS 95024-3-1:2010	Condensation
Pollution	EN 61131-2	Degree of pollution 2

3 Hardware description

3.1 Properties

053-1PN01

- Field bus: PROFINET according IEC 61158-6-10, IEC 61784-2
- PROFINET for max. 64 periphery modules
- Max. 512byte input and 512byte output data
- Integrated 2-port switch
- Transfer rate 100Mbit/s full-duplex
- Integrated DC 24V power supply for power and electronic section supply of the periphery modules
- Supports MRP slave (**M**edia **R**edundancy **P**rotocol) as MRP client
- Supports Shared device with up to 3 connections
- Supports FMM (**F**ree **M**odule **M**apping)
- Supports Easy Maintenance
- Supports multiple and single write (acyclic communication)
- Supports IRT (**I**sochronous **R**eal **T**ime communication)
 - Minimum update time 250µs with IRT
- Isochrone mode
- Device replacement without removable medium / PG port diagnostics
- Integrated Web server
- Integrated DHCP client
- LEDs for status display

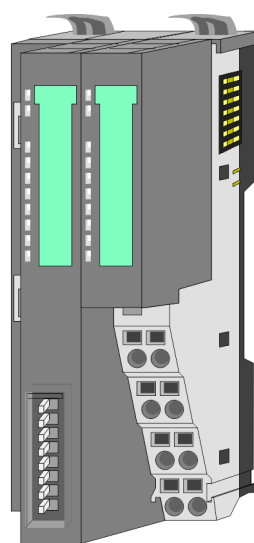

Ordering data

Type	Order number	Description
IM 053PN	053-1PN01	PROFINET IO device for System SLIO

3.2 Structure

053-1PN01

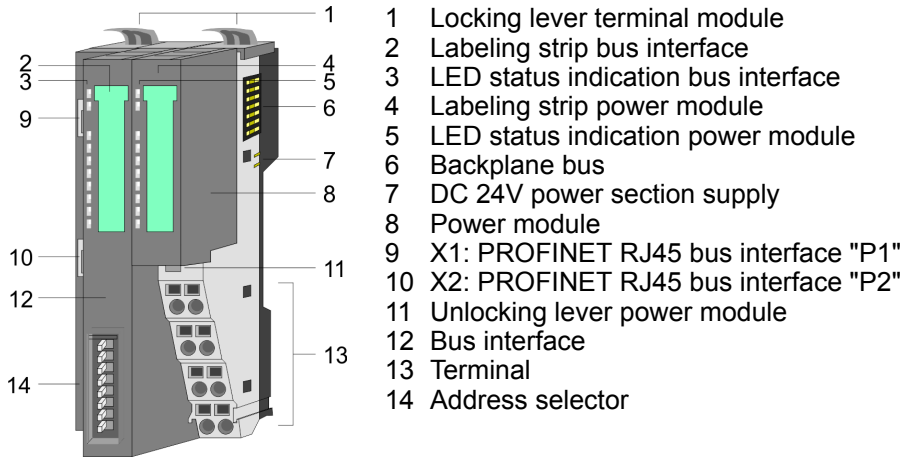

3.2.1 Interfaces

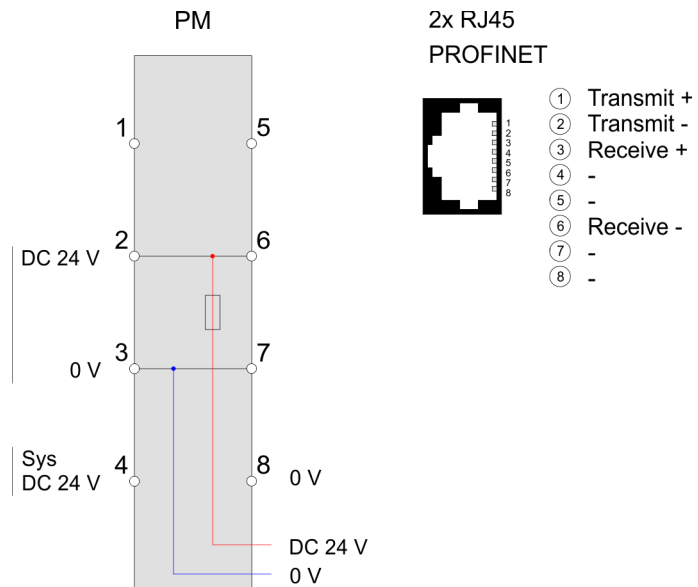

CAUTION!

Bus interface and power module of the bus coupler may not be separated!

Here you may only exchange the electronic module!

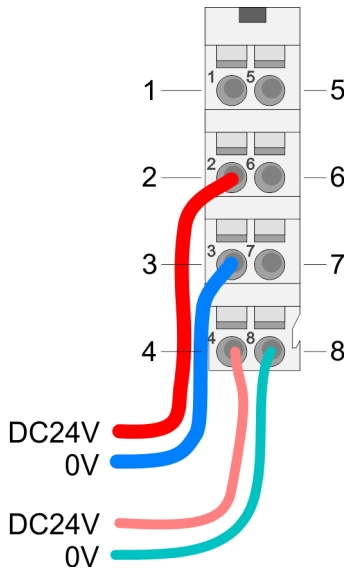
PM - Power module

For wires with a core cross-section of 0.08mm² up to 1.5mm².

Pos.	Function	Type	Description
1	---	---	not connected
2	DC 24V	I	DC 24V for power section supply
3	0V	I	GND for power section supply
4	Sys DC 24V	I	DC 24V for electronic section supply
5	---	---	not connected
6	DC 24V	I	DC 24V for power section supply
7	0V	I	GND for power section supply
8	Sys 0V	I	GND for electronic section supply

I: Input

X1/X2: PROFINET interface*RJ45 jacks*

- Ethernet connection via 2 RJ45 jacks (2 port switch)
- Auto negotiation (negotiates the transfer parameters)
- Auto crossover (transmission and receipt lines are automatically crossed if necessary)

Address switch



- A PROFINET name may only once exist on the bus! Changes of the address switch were only recognized after PowerON or a Reset!
- The PROFINET name preset at the address switch must always be identical to the device name in your project!

The address switch serves for the following settings:

- Selection of the address usage
- Presetting of the PROFINET name

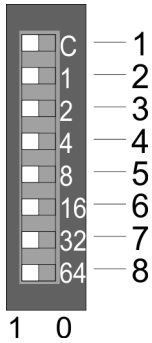

Position	Description
1	DHCP client <ul style="list-style-type: none"> ■ 0 = disabled ■ 1 = enabled
2	$2^0 = 1$
3	$2^1 = 2$
4	$2^2 = 4$
5	$2^3 = 8$
6	$2^4 = 16$
7	$2^5 = 32$
8	$2^6 = 64$

PROFINET name:
 "... 053-1PN01-xxx"
 with xxx = decimal value of position 2 ... 8

Essential switch settings

Position	State	Behavior at start-up
1	1	<ul style="list-style-type: none"> ■ DHCP client is activated. ■ The IP address data are requested via DHCP. ■ The IP address data are not stored in the flash, respectively 1. DHCP offer is used. ■ DHCP client is disabled if the 1. new IP settings were received via DCP or the 1. PROFINET connection was established.
1	0	<ul style="list-style-type: none"> ■ DHCP client is disabled.
2 ... 8	0	<ul style="list-style-type: none"> ■ PROFINET compliant (IEC 61158-6-10, IEC 61784-2) PROFINET name (device name) respectively IP address parameter come from flash memory. ■ Here the device name may be free selected. ■ Please regard that you have to assign the device name respectively the IP address to the PROFINET device by means of an initialization. Otherwise, this can not be found by the PROFINET controller.
2 ... 8	[1...127]	<ul style="list-style-type: none"> ■ PROFINET name (device name): <ul style="list-style-type: none"> - "... 053-1PN01-xxx" with xxx = decimal value of position 2 ... 8 ($2^0 \dots 2^6$) ■ Enter within your project a PROFINET name into the properties of the PROFINET device and set the same name at the address switch. Here the IP address parameters may also be preset.

3.2.2 LEDs

LEDs power module

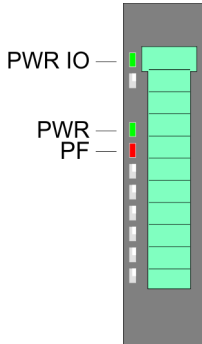

PWR IO	PWR	PF	Description
green	green	red	
	X	<input type="checkbox"/>	Power section supply OK
		<input type="checkbox"/>	Electronic section supply OK
X	X		Fuse electronic section supply defective
not relevant: X			



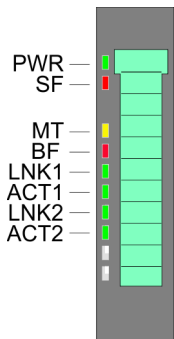



















Status indication bus interface



LED	Color	Description
PWR	green	Bus interface is power supplied
SF	red	System error: Error at PROFINET or System SLIO bus
MT	yellow	Maintenance PROFINET
BF	red	Bus error: Error in PROFINET communication
LNK1/2	green	Link 1/2: Physical link to Ethernet
ACT1/2	green	Activity 1/2: Communication via Ethernet

PWR	SF	MT	BF	LNK1	ACT1	LNK2	ACT2	Description
green	red	yellow	red	green	green	green	green	
	X	X	X	X	X	X	X	The PROFINET IO device is power supplied.
	<input type="checkbox"/>	X	0.5Hz	[]	X	[]	X	No connection can be established to the PROFINET IO controller, but there is a connection to the switch (no AR is active). LNK1 or LNK2 is on.
	<input type="checkbox"/>	X		<input type="checkbox"/>	<input type="checkbox"/>	<input type="checkbox"/>	<input type="checkbox"/>	There is no physical connection to Ethernet. LNK1 and LNK2 is off.
	X	X	<input type="checkbox"/>	[]	P	[]	P	A connection to a PROFINET IO controller is established (at least one AR is active) LNK1 or LNK2 is on.
		X	X	X	X	X	X	<ul style="list-style-type: none"> An unacknowledged diagnostic message is available. Error on the backplane bus (e.g. module failure, bus faulted). Error during firmware update (shortly visible, then restart).

Structure > LEDs

PWR  green	SF  red	MT  yellow	BF  red	LNK1  green	ACT1  green	LNK2  green	ACT2  green	Description
	 2Hz	X			X		X	Error IP address <ul style="list-style-type: none"> There was not assigned a valid IP address. The assigned IP address already exists in the system.
	X	 1Hz	 1Hz	X	X	X	X	A firmware update is in progress. Here BF and MT flash alternately.
	X	X	X	 2Hz	X	 2Hz	X	Identification via DCP. Depending on the connection LNK1 or LNK2 are flashing with 2Hz for 3 seconds.
			X	X	X	X	X	Maintenance request <ul style="list-style-type: none"> System SLIO: Version error (001Eh) IO device: Unexpected restart(0101h) FMM configuration has been changed (0109h) Invalid reference configuration (Maintenance Mode - 0120h) ↗ <i>ChannelErrorTypes</i>

Pulsing: P | Option: [] | not relevant: X

3.3 Technical data

Order no.	053-1PN01
Type	IM 053PN - PROFINET IO device
Module ID	-
Technical data power supply	
Power supply (rated value)	DC 24 V
Power supply (permitted range)	DC 20.4...28.8 V
Reverse polarity protection	✓
Current consumption (no-load operation)	95 mA
Current consumption (rated value)	0.95 A
Inrush current	3.9 A
I ² t	0.14 A ² s
Max. current drain at backplane bus	3 A
Max. current drain load supply	10 A
Power loss	3 W
Status information, alarms, diagnostics	
Status display	yes
Interrupts	yes, parameterizable
Process alarm	yes, parameterizable
Diagnostic interrupt	yes, parameterizable
Diagnostic functions	yes, parameterizable
Diagnostics information read-out	possible
Supply voltage display	green LED
Service Indicator	yellow LED
Group error display	red SF LED
Channel error display	none
Hardware configuration	
Racks, max.	1
Modules per rack, max.	64
Number of digital modules, max.	64
Number of analog modules, max.	64
Communication	
Fieldbus	PROFINET-IO
Type of interface	Ethernet 100 MBit
Connector	2 x RJ45
Topology	Line, Star
Electrically isolated	✓

Technical data

Order no.	053-1PN01
Number of participants, max.	-
Node addresses	-
Transmission speed, min.	100 Mbit/s
Transmission speed, max.	100 Mbit/s
Address range inputs, max.	512 Byte
Address range outputs, max.	512 Byte
Number of TxPDOs, max.	-
Number of RxPDOs, max.	-
Supported profile	-
Supported transfer cycle	-
Cyclic data size per node	-
Max. Number of nodes	-
Supported communication method	-
Supported command "Cyclic"	-
Supported command "Event driven"	-
Supported command "Message"	-
Datasizes	
Input bytes	-
Output bytes	-
Parameter bytes	-
Diagnostic bytes	-
Housing	
Material	PPE / PPE GF10
Mounting	Profile rail 35 mm
Mechanical data	
Dimensions (WxHxD)	48.5 mm x 109 mm x 76.5 mm
Net weight	160 g
Weight including accessories	160 g
Gross weight	175 g
Environmental conditions	
Operating temperature	0 °C to 60 °C
Storage temperature	-25 °C to 70 °C
Certifications	
UL certification	yes
KC certification	yes

4 Deployment

4.1 Basics PROFINET

General

- PROFINET is an open Industrial Ethernet Standard from PROFIBUS & PROFINET International (PI) for automation.
- PROFINET is standardized in the IEC 61158.
- PROFINET uses TCP/IP and IT standards and supplements the PROFIBUS technology for applications, where fast data communication with industrial IT functions is demanded.

There are 2 PROFINET function classes:

- PROFINET IO
- PROFINET CBA

These may be realized in 3 performance steps:

- TCP/IP communication
- RT communication
- IRT communication

PROFINET IO

- With PROFINET IO an I/O data sight to the distributed periphery is described.
- PROFINET IO describes the whole data transfer between IO controller and IO device.
- PROFINET is configured like PROFIBUS.
- PROFINET IO always contains the real time concept.
- Contrary to the master-slave procedure of PROFIBUS, PROFINET uses the provider-consumer model. This supports the communication relations (AR = Application Relation) between equal participants in the Ethernet. Here the provider sends its data without a request of the communication partner.
- Apart from the user data exchange also functions for parametrization and diagnostics are supported.

PROFINET CBA

- PROFINET CBA means **Component Based Automation**.
- This component model describes the communication between autonomously working stations.
- It makes a simple modularization of complex plants possible, by distributed intelligence by means of graphic configuration for communication of intelligent modules.

TCP/IP communication

This is the open communication via Ethernet TCP/IP without any demand on real-time.

RT Communication

- RT means **Real-Time**.
- The RT communication represents the basics for data transfer at PROFINET IO.
- Here RT data are handled with higher priority.

IRT Communication

- IRT means **Isochronous Real-Time**.
- With the IRT communication the bus cycle begins clock-exactly i.e. with a maximum permissible tolerance and is again synchronized. Thereby the time-controlled and synchronous transfer of data is guaranteed.
- Here sync telegrams of a sync master in the network serve for.

Properties of PROFINET

PROFINET of IEC 61158 has the following properties:

- Full-duplex transfer with 100MBit/s via copper respectively fibre optics.
- Switched Ethernet
- Auto negotiation (negotiates the transfer parameters)
- Auto crossover (transmission and receipt lines are crossed automatically if necessary)
- Wireless communication via WLAN
- UDP/IP is used as overlaid protocol. UDP means **U**ser **D**atagram **P**rotocol and contains the unprotected connectionless broadcast communication within IP.

PROFINET devices

Like PROFIBUS DP also with PROFINET IO the following devices are classified according to their tasks:

- IO controller
 - The *IO controller* is equivalent to the master of PROFIBUS.
 - This is the PLC with PROFINET connection, in which the PLC program runs.
- IO device
 - The *IO device* is a distributed I/O field device, which is connected to PROFINET.
 - The IO device is equal to the slave of PROFIBUS.
- IO supervisor
 - The *IO supervisor* is an engineering station as e.g. programming unit, PC or HMI interface for commissioning and diagnostics.

AR

AR (**A**pplication **R**elation) corresponds to a connection to an IO controller or IO supervisor.

API

- API means **A**pplication **P**rocess **I**dentifier and defines besides *Slot* and *Subslot* a further addressing level.
- With this additional addressing mode with using of different applications, the overlapping of data areas can be prevented.
- The following APIs are currently supported by the PROFINET IO devices:
 - DEFAULT_API (0x00000000)
 - DRIVE_API (0x00003A00)
 - ENCODER_API (0x00003D00)
 - FIELDBUS_INTEGRATION_API (0x00004600)
 - PROFINET_IO_LINK_API (0x00004E01)
 - RFID_READER_API (0x00005B00)
 - BARCODE_READER_API (0x00005B10)
 - INTELLIGENT_PUMP_API (0x00005D00)
 - PROCESS_AUTOMATION_API (0x00009700)

IOCS/IOPS

Each data element of the cyclic I/O data has 1 status byte for validation.

- For the receiver of input data this is the *IO Consumer Status (IOCS)*.
- For the sender of output data this is the *IO Provider Status (IOPS)*.
- If the data element could be transmitted without error, bit 7 of the status byte is set (80h: state GOOD).
- If an error occurred during the data transfer of the data element, bit 7 of the status byte is not set (00h: state BAD).

- GSDML file**
- To configure a device I/O connection in your own configuration tool, you've got all the information about your PROFINET components in form of a GSDML file. This file may be found for System SLIO in the 'Download Center' of www.yaskawa.eu.com under 'GSDML 053-1PN01'.
 - Please install the GSDML file in your configuration tool.
 - More information about installing the GSDML file may be found at the manual of the according engineering tool.
 - Structure and content of the GSDML file are defined by IEC 61158.

- Addressing**
- In contrast to the PROFIBUS address, in PROFINET each device may be definitely identified with its PROFINET interface:
- Device name
 - IP address respectively MAC address

- Transfer medium**
- PROFINET is compatible to Ethernet in accordance with the IEEE standards. The connection of the PROFINET IO field devices is exclusively established via switches as network components. This is made either as star via multi-port switches or as line by means of switches, integrated to the field devices.

4.2 PROFINET installation guidelines

- Generals to data security**
- The topic of data security and access protection have become increasingly important in the industrial environment. The increased networking of entire industrial systems to the network levels within the company together with the functions of remote maintenance have all served to increase vulnerability.
 - Threats can arise from internal manipulation like technical errors, operator and program errors respectively from external manipulation like software viruses and worms, trojans and password phishing.

- Precautions**
- The most important precautions to prevent manipulation and loss of data security in the industrial environment are:
- Encrypting the data traffic by means of certificates.
 - Filtering and inspection of the traffic by means of VPN - "Virtual Private Networks".
 - Identification of the nodes by "Authentication" via save channels.
 - Segmenting in protected automation cells, so that only devices in the same group can exchange data.

- Guidelines for information security**
- With the "VDI/VDE 2182 sheet 1", Information Security in the Industrial Automation - General procedural model, VDI guidelines, the VDI/VDE society for measuring and automation engineering has published a guide for implementing a security architecture in the industrial environment. The guideline can be found at www.vdi.de
 - PROFIBUS & PROFINET International (PI) can support you in setting up security standards by means of the "PROFINET Security Guideline". More concerning this can be found at the corresponding web site e.g. www.profibus.com

Industrial Ethernet

- Due to the open standard of PROFINET standard Ethernet components may be used. For industrial environment and due to the high transfer rate of 100MBit/s you PROFINET system should consist of Industrial Ethernet components.
- All the devices interconnected by switches are located in one and the same network. All the devices in a network can communicate directly with each other.
- A network is physically limited by a router. If devices need to communicate beyond the limits of a network, you have to configure the router so that it allows this communication to take place.

Topology**Linear**

- With the linear structure all the communication devices are connected via a linear bus topology. Here the linear bus topology is realized with switches that are already integrated into the PROFINET device.
- If a communication member fails, communication across the failed member is no longer possible.

Star

- If you connect communication devices to a switch with more than 2 PROFINET ports, you automatically create a star network topology.
- If an individual PROFINET device fails, this does not automatically lead to failure of the entire network, in contrast to other structures. It is only if a switch fails that part of the communication network will fail as well.

Ring

In order to increase the availability of a network the both open ends of a linear bus topology may be connected by a switch. By configuring the switch as redundancy manager on a break in the network it ensures that the data is redirected over an intact network connection.

Tree

If you interconnect several star structures, you obtain a tree network topology.

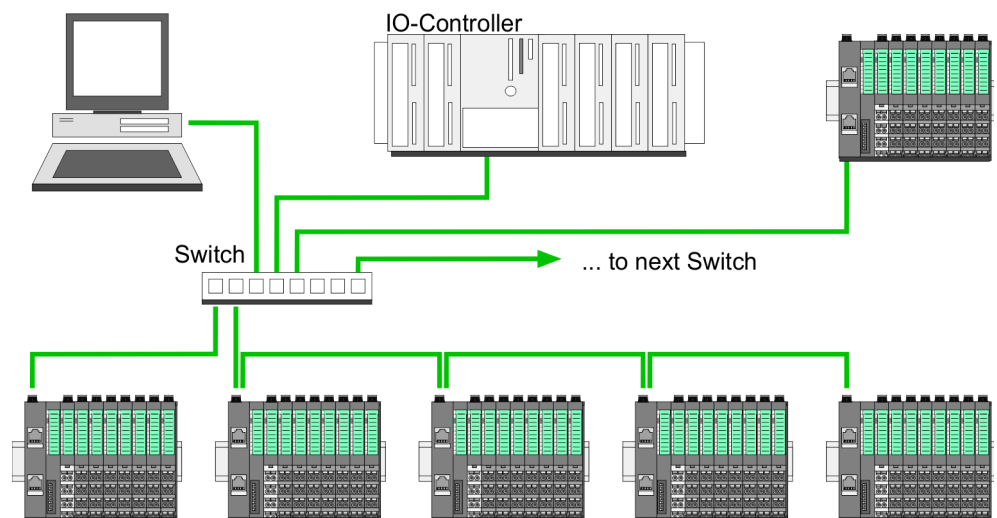
Example network

4.3 Accessing the System SLIO

4.3.1 General

Overview

Information concerning the allocation of these areas may be found in the description of the corresponding System SLIO module. In the following you will find the description of accessing the following System SLIO areas via PROFINET:

- I/O area
- Parameter data
- Hardware interrupt data
- Diagnostic data



Please consider the System SLIO power and clamp modules do not have any module ID. These may not be recognized by the PROFINET IO device and so are not listed respectively considered during slot allocation.

GSDML file

- To configure a device I/O connection in your own configuration tool, you've got all the information about your PROFINET components in form of a GSDML file. This file may be found for System SLIO in the 'Download Center' of www.yaskawa.eu.com under 'GSDML 053-1PN01'.
- Please install the GSDML file in your configuration tool.
- More information about installing the GSDML file may be found at the manual of the according engineering tool.
- Structure and content of the GSDML file are defined by IEC 61158.

Handling blocks

- To set respectively change parameters during runtime there are according handling blocks for record set read/write necessary.
- There are the following handling blocks available for CPUs, programmable with Siemens STEP7:
 - SFB 52 - RDREC - read Record set (index)
 - SFB 53 - WRREC - write record set
 - SFB 54 - RALARM - read diagnostics data

Here the *Module slot* respectively *Slot* is addressed by the logic *start address* as a *record set* via the corresponding *Index*.

Acyclic access to the System SLIO

- The acyclic access to the PROFINET IO device happens by reading respectively writing a record set via *Index* from respectively to the wanted API, slot or subslot.
- Currently the PROFINET IO device supports API 0. More about the frame structure can be found in the current PROFINET specification.



Overview of all via PROFINET IO device addressable index numbers
 ↪ *Chap. 4.14 'Index overview' page 93*

4.3.2 Accessing the I/O area

- At PROFINET the input respectively output area is automatically embedded to the corresponding address area of the master system.
- By means of the handling block SFB 52 - RDREC the I/O area can be acyclically accessed via the following index numbers:
 - Index = 8028h: Read input data (Slot 1 ... 64 / Subslot 1)
 - Index = 8029h: Read output data (slot 1 ... 64 / subslot 1)

Behavior of the outputs

- Send output data *IO Provider Status* IOPS = State BAD ↪ *IOCS/IOPS*
 - With deactivated substitute values (parametrization data: Byte 5: Bit 5) the *IO Provider Status* (IOPS) for output data of a module is set to BAD state by the PROFINET controller, digital outputs are set to 0, analog outputs are set to the minimum of the value range depending on the parametrization and with function modules all enable bits are set to 0.
 - If substitute values are activated (parametrization data: byte 5: bit 5), the last valid output value is retained. ↪ *Parameter data*
- Interrupting a connection
 - If substitute values are deactivated (parametrization data: byte 5, bit 5) and the PROFINET connection is interrupted without disconnecting the Ethernet connection, BASP is activated. ↪ *Parameter data*
 - If substitute values are activated and the PROFINET connection is interrupted, the last valid output value is retained.
 - If the Ethernet connection is disconnected, BASP is activated.
- PowerOn
 - With PowerOn BASP is active.
 - When the IM 053-1PN01 is power supplied, PWR LED gets on.

BASP

BASP (**B**efehls-**A**usgabe-**S**perre) means command output disable. If BASP is active, all module outputs are switched off and the inputs are not read.



Further information on operating states and functional safety can be found in the manual of your CPU.

4.3.3 Accessing the parameter data

- With each connection setup parameter data for modules and IO device are written from the IO controller to the device, as defined in the GSDML file.
- After a connection setup there is the possibility to read parameters from a module with SFC 52 - RDREC and to write parameters to a module with SFC 53 - WRREC.
- The parameters are activated as soon as they were written.

Access	Slot (subslot always 1)	Index
All parameters of the PROFINET IO device incl. header (4byte)	0	<ul style="list-style-type: none"> ■ 007Dh – can also be addressed via 007Eh
All parameters of the module incl. header (4byte)	1 ... 64	<ul style="list-style-type: none"> ■ 007Dh – can also be addressed via 007Eh



Information concerning the allocation of these areas may be found in the description of the corresponding System SLIO module.

4.3.4 Accessing diagnostics data

- Hardware interrupt data
 - Hardware interrupt data of System SLIO modules with interrupt capability were automatically sent by a diagnostics message if the interrupt is activated by parametrization at the corresponding module respectively at the System SLIO PROFINET IO device.
 - On an hardware interrupt your master system jumps into an interrupt routine. There you can read the hardware interrupt data by means of the block SFB 54 - RALARM
 - ↳ *Chap. 4.12.1 'Hardware interrupt' page 84*
- Diagnostic interrupt data
 - Diagnostics interrupt data of System SLIO modules with interrupt capability were automatically sent by a diagnostics message if the interrupt is activated by parametrization at the corresponding module respectively at the System SLIO PROFINET IO device.
 - On an diagnostics interrupt your master system jumps into an interrupt routine. There you can read the diagnostics interrupt data by means of the block SFB 54 - RALARM.
 - The interrupt behaviour and the structure of the diagnostics data may be preset by the parametrization of the System SLIO PROFINET IO device.
 - By means of the handling block SFB 52 - RDREC the last sent diagnostics data can acyclically be read from the module.
 - ↳ *Chap. 4.12.2 'Diagnostic interrupt' page 85*

4.4 Project engineering

General

- For project engineering a hardware configuration is established within a PROFINET engineering tool like the Siemens SIMATIC Manager. Here you assign the according IO device to the IO controller.
- A direct assignment takes place via the PROFINET device name that you set at the IO device with its address selector and the properties of the IO device.
- By installing the corresponding GSDML file the IM 053-1PN01 PROFINET IO device is listed as "... 053-1PN01" at:
'PROFINET IO → Additional field devices → I/O → ... SLIO System'.



For applications via IRT, the PROFINET 'DataHoldFactor' in your PROFINET configuration tool set to ≥ 12 cycles and activate the diagnostic interrupts in 053-1PN01.

GSDML file

- To configure a device I/O connection in your own configuration tool, you've got all the information about your PROFINET components in form of a GSDML file. This file may be found for System SLIO in the 'Download Center' of www.yaskawa.eu.com under 'GSDML 053-1PN01'.
- Please install the GSDML file in your configuration tool.
- More information about installing the GSDML file may be found at the manual of the according engineering tool.
- Structure and content of the GSDML file are defined by IEC 61158.

Name of the device

- So that the PROFINET controller can identify a PROFINET device, you have to assign an appropriate device name to the PROFINET device, before. This name must be always identical to the device name in your project!
- To assign a device name there is an address switch on the PROFINET device.
- If all switches are 0, you can freely define a name in your project. Via an "initialization" a name is to be assigned to the PROFINET IO device and retentive stored there. Otherwise the device has the following name: ... 053-1PN01-xxx with xxx = decimal value of position 2 ... 8 (2^0 ... 2^6) of the switch.

Address switch



- A PROFINET name may only once exist on the bus! Changes of the address switch were only recognized after PowerON or a Reset!
- The PROFINET name preset at the address switch must always be identical to the device name in your project!

The address switch serves for the following settings:

- Selection of the address usage
- Presetting of the PROFINET name

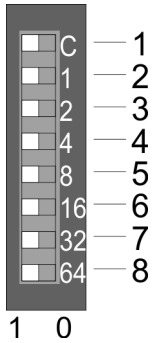

Position	Description
1	DHCP client <ul style="list-style-type: none"> ■ 0 = disabled ■ 1 = enabled
2	$2^0 = 1$
3	$2^1 = 2$
4	$2^2 = 4$
5	$2^3 = 8$
6	$2^4 = 16$
7	$2^5 = 32$
8	$2^6 = 64$

PROFINET name:
 "... 053-1PN01-xxx"
 with xxx = decimal value of position 2 ... 8

Essential switch settings

Position	State	Behavior at start-up
1	1	<ul style="list-style-type: none"> ■ DHCP client is activated. ■ The IP address data are requested via DHCP. ■ The IP address data are not stored in the flash, respectively 1. DHCP offer is used. ■ DHCP client is disabled if the 1. new IP settings were received via DCP or the 1. PROFINET connection was established.
1	0	<ul style="list-style-type: none"> ■ DHCP client is disabled.
2 ... 8	0	<ul style="list-style-type: none"> ■ PROFINET compliant (IEC 61158-6-10, IEC 61784-2) PROFINET name (device name) respectively IP address parameter come from flash memory. ■ Here the device name may be free selected. ■ Please regard that you have to assign the device name respectively the IP address to the PROFINET device by means of an initialization. Otherwise, this can not be found by the PROFINET controller.
2 ... 8	[1...127]	<ul style="list-style-type: none"> ■ PROFINET name (device name): <ul style="list-style-type: none"> - "... 053-1PN01-xxx" with xxx = decimal value of position 2 ... 8 ($2^0 \dots 2^6$) ■ Enter within your project a PROFINET name into the properties of the PROFINET device and set the same name at the address switch. Here the IP address parameters may also be preset.

Initialization - device name assignment

If all the switches of the address switch of the PROFINET device are 0, on the example of the Siemens SIMATIC Manager with the following proceeding you can assign a name to your PROFINET IO device, which is retentive stored there.

1. ➤ Check if the switches of the address switch of the PROFINET device are 0 and perform PowerON.
2. ➤ Load your project.
3. ➤ Choose your PROFINET controller.
4. ➤ Go to '*PLC functions* ➔ *Edit Ethernet node*'.
5. ➤ Click at "Ethernet node" at [Browse]. Every reachable stations are listed.
6. ➤ Choose the PROFINET device with the suited MAC address and click on [OK]. The MAC address may be found at the front of the module. If the device name begins instead with "... 053-1PN01...", so not all the switches of the address switch are 0! Please correct this.
7. ➤ Enter at "Assign device name" the device name of your project and click at [Assign Name]. The name is retentive stored in the PROFINET IO device. With [Reset] at "reset to factory settings" the name may be deleted.

Reset to factory settings

1. ➤ Start the Siemens SIMATIC Manager
2. ➤ Go to '*PLC functions* ➔ *Edit Ethernet node*'.
3. ➤ Click at "Ethernet node" at [Browse]. Every reachable stations are listed.
4. ➤ Choose the PROFINET device with the suited MAC address and click on [OK].
5. ➤ With [Reset] at "reset to factory settings" the PROFINET IO device is reset to factory setting

Project engineering

1. ➤ Mount your PROFINET system.
2. ➤ Start your project engineering tool with a new project.
3. ➤ For the project engineering of the IM 053-1PN01 take the "... 053-1PN01" from the hardware catalog and drag it to the PROFINET subnet.
4. ➤ Open via double click to the inserted symbol the properties dialog of the PROFINET device and enter at "General" the *device name*, which was preset by the address switch. Confirm with [OK].
5. ➤ For parametrization of the PROFINET device the product specific properties dialog may be opened in the slot overview .
6. ➤ Insert the peripheral modules from the hardware catalog and parametrize them if necessary.
7. ➤ Transfer your project to the PLC.

4.4.1 Parameter data

PROFINET IO device

Byte	Bit 7 ... Bit 0	Default
0	<ul style="list-style-type: none"> ■ Bit 0: Process interrupt <ul style="list-style-type: none"> – 0: disable – 1: enable ■ Bit 1: Diagnostic interrupt <ul style="list-style-type: none"> – 0: disable – 1: enable ■ Bit 2: reserved ■ Bit 3: Auto acknowledge <ul style="list-style-type: none"> – 0: disable – 1: enable ■ Bit 4: reserved ■ Bit 5: Web server <ul style="list-style-type: none"> – 0: disable – 1: enable ■ Bit 6: reserved ■ Bit 7: Data format <ul style="list-style-type: none"> – 0: Data format Motorola – 1: Data format Intel 	0Bh
1 ... 4	00h (fix)	00h
5	<ul style="list-style-type: none"> ■ Bit 0: FMM - Activation <ul style="list-style-type: none"> – 0: disable – 1: enable ■ Bit 1: FMM - automatic restart <ul style="list-style-type: none"> – 0: disable – 1: enable ■ Bit 3, 2: Diagnostic interrupt type <ul style="list-style-type: none"> – 01: Extended channel diagnostics – 10: Channel diagnostics – 11: Manufacturer-specific diagnostics ■ Bit 4: reserved ■ Bit 5: Replacement values - activation <ul style="list-style-type: none"> – 0: disable – 1: enable ■ Bit 7 ... 6: reserved 	04h

- Diagnostic interrupt type
Here the structure of the diagnostic interrupt data may be defined, which were sent on error via diagnostic telegram respectively which may be requested by the standard PROFINET Index numbers.
- Auto acknowledge
Acknowledgement of interrupts on the System SLIO back plane bus:
 - With *Auto-Acknowledge* = 0 you are responsible for the acknowledgement. So you are informed with every interrupt. As soon as an interrupt is not acknowledged by the PROFINET controller, other interrupts of the module are blocked.
 - With *Auto-Acknowledge* = 1 each interrupt is automatically acknowledged by the PROFINET device. In this mode the diagnostics data were always overwritten by new interrupts. Default setting is *Auto-Acknowledge* = 1. For continuous use *Auto-Acknowledge* should be activated.
- Data format Motorola/Intel
This parameter refers to how a value is stored in the CPU address range:
 - In the *Motorola format* (default) the bytes were stored in descending significance, i.e. the 1. byte contains the high byte and 2. byte the low byte.
 - In the *Intel-Format* the bytes are stored in ascending significance, i.e. the 1. byte contains the low byte and 2. byte the high byte.

4.5 Web server



Please consider the System SLIO power and clamp modules do not have any module ID. These may not be recognized by the IM 053-1PN01 and so are not listed respectively considered during slot allocation.

Access via IP address

On delivery the IM 053-1PN01 device has no IP address. So that you can access the web server you have to assign IP address data to this. There are the following possibilities:

- Activate the DHCP client via DIP switch 1 of the address switch and get an IP address from your DHCP server in the network.
- Assign IP address data by means of a DCP tool.
- Assign via an IO controller IP address data. It gives you access to the Web server to accordingly change the IP address data there.

Structure of the web page

The web page is built dynamically and depends on the number of modules, which are connected to the IM 053-1PN01.

The screenshot shows the web page for the IM 053-1PN01 device. On the left, there is a module list with three entries: 'Device (053-1PN01)', 'Module 1 (... 021-1BD00)', and 'Module 2 (... 031-1BD80)'. A red arrow labeled '1' points to this list. At the top, there is a navigation menu with tabs: 'Info', 'Data', 'Parameter', 'Diagnosis', 'Security', 'IP', 'Firmware', and 'Configuration'. A red arrow labeled '2' points to this menu. The main content area displays 'Device (053-1PN01) Information' with a table of parameters and values. A red arrow labeled '3' points to this table.

Name	Value
Ordering Info	053-1PN01
Serial	01902682
Version	01V10.001
HW Revision	01
Software	1.0.0.2

[Expert View ...]

- [1] Module list: IM 053-1PN01 and System SLIO modules in plugged order
- [2] Functions for the module, which is selected in the *module list*
- [3] Information respectively input field for the according function



For fast diagnostic missing or incorrectly configured modules are shown after updating the Web page in the module list in red.

Web server

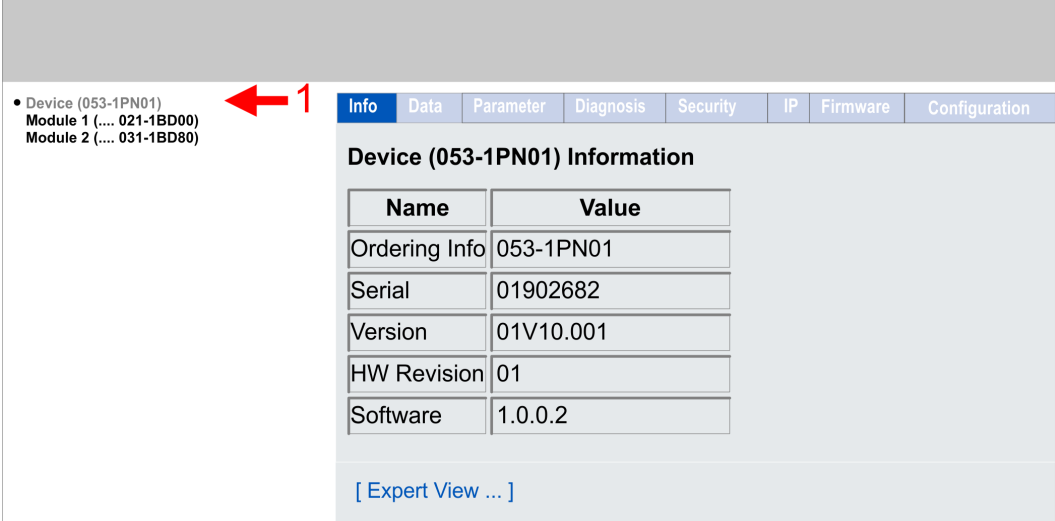
Web page with selected IM 053-1PN01

The screenshot shows a web interface with a sidebar on the left and a main content area on the right. The sidebar contains a list of items: 'Device (053-1PN01)', 'Module 1 (... 021-1BD00)', and 'Module 2 (... 031-1BD80)'. A red arrow points to the 'Device (053-1PN01)' item. The main content area has a tabbed interface with tabs for 'Info', 'Data', 'Parameter', 'Diagnosis', 'Security', 'IP', 'Firmware', and 'Configuration'. The 'Info' tab is selected, displaying 'Device (053-1PN01) Information' in a table format. Below the table is a link for '[Expert View ...]'.

Name	Value
Ordering Info	053-1PN01
Serial	01902682
Version	01V10.001
HW Revision	01
Software	1.0.0.2

- Info
 - Here order number, serial number and the version of firmware and hardware of the IM 053-1PN01 are listed.
- Data
 - Here, the process data of the IM 053-1PN01 and of the modules are shown.
- Parameter
 - Here you can see the current parameters of the IM 053-1PN01.
- Diagnosis
 - Configuration State
Deviations between the setpoint and actual configuration are shown here (OK: no deviation).
 - Diagnosis Entries
Here all pending diagnostic messages are shown.
 - Diagnosis Buffer
Here the content of the diagnostics buffer is listed.
- Security
 - All functions for the writing access to the IM 053-1PN01 can be secured by a password.
- IP
 - Here you can see the current IP address data of the IM 053-1PN01.

- Firmware
 - With this function you can bring in a firmware update. ↪ *Firmware update*
- Configuration
 - Activate setting mode
Here you can activate or deactivate the *Active setting mode*. ↪ *Active setting mode*
 - Export current configuration (IP Settings / Device Parameters / Module Parameters)
Here you can export the current configuration (IP settings, parameters IO device and modules) as an XML file.
 - Import and apply configuration (IP Settings / Device Parameters / Module Parameters)
Here you can import and activate a saved configuration from an XML file.
 - Save current Device Parameters / Module Parameters into remanent memory
This function is currently not supported.
 - Delete remanent Device Parameters / Module parameters
This function is currently not supported.
 - Import and apply Module Parameters
Here you can import and activate a configuration from an XML file, whereby only the module parameters are used.

Firmware update



CAUTION!

- When installing a new firmware you have to be extremely careful. Under certain circumstances you may destroy the IM 053-1PN01, for example if the voltage supply is interrupted during transfer or if the firmware file is defective. In this case, please call the Yaskawa Hot-line!
- Please regard that the version of the update firmware has to be different from the existing firmware otherwise no update is executed.



Please note that a firmware update is only possible if no active connection to the PROFINET controller is established.

1. ➤ You can find current firmware versions in the 'Download Center' of www.yaskawa.eu.com at 'Firmware 053-1PN01'.
2. ➤ Select the Px000312.pkg file for download and load it into your working directory.
3. ➤ Click at 'Firmware' in the web server.
4. ➤ Navigate to your work directory and load the file Px000312.pkg to the IM 053-1PN01.



- *After the package has been completely transferred to the IM 053-1PN01, the firmware update starts automatically. Here the SF and MT LEDs blink alternately.*
- *During this process, the IM 053-1PN01 must never be disconnected from the power supply!*

5. ➤ When the firmware update is finished (LEDs SF and MT stop blinking), a restart automatically happens.
 - ⇒ This will apply your new firmware file.

Active setting mode



CAUTION!

- Please consider that controlling of output values represents a potentially dangerous condition.
- As long as *Active setting mode* is activated, set variables retain their value.
- *Active setting mode* should only be used for test purposes respectively for troubleshooting.

Activation of the *Active setting mode* is only possible via the web server. If the connection to a PROFINET controller is established when the *Active setting mode* is activated, the *Active setting mode* is automatically deactivated again. If *Active setting mode* is activated, you have the following options:

- Set outputs via the web page when the module is selected.
- Parametrization of non-locked parameters via the web page when the module is selected.

Expert View

[Expert View] takes you to the advanced "Expert View".

HARDWARE		Hardware
MxFile	MX000346.101	Hardware information
ASIC/FPGA Version	V311	
BootLoader Version	V01.00.02.00	
HwTest Version	V01.00.02.00	
FwBackup Version	V00.00.00.00	

Ethernet Interface		Interfaces
MacAddressIF	00-20-D5-09-3F-E5	Mac address interface
MacAddressX1	00-20-D5-09-3F-E6	Mac address X1
MacAddressX2	00-20-D5-09-3F-E7	Mac address X2

PROFINET		PROFINET
VendorID	0x22B	Support information
DeviceID	0x18C5	

System		System
Load Level	0%	Support information

FMM configuration		FMM
Assigned Slots	N/A (1:1 Mapping)	Support information

PROFINET Connections		PROFINET connections
1	IP: 172.20.140.96 / Name: pn-io-2 Modules: 0 1 2 3 4 5 6 7	Support information
2	-	
3	-	

Web page with selected module

The screenshot shows a web interface for a device. On the left, a tree view lists 'Device (053-1PN01)', 'Module 1 (... 021-1BD00)', and 'Module 2 (... 021-1BF00)'. A red arrow points from 'Module 1 (... 021-1BF00)' to the 'Info' tab of a table on the right. The table is titled 'Module 1 (... 021-1BF00) Information' and has tabs for 'Info', 'Data', 'Parameter', and 'Diagnosis'. The 'Info' tab is active, showing a table with the following data:

Name	Value
Ordering Info	021-1BF00
Serial	00101556
Version	01V30.003
HW Revision	01
Software	1.2.8.0

Below the table is a link: [Expert View ...]

- Info
 - Here product name, order number, serial number, firmware version and hardware state number of the according module are listed.
- Data
 - At Data the states of the inputs respectively outputs are listed.
- Parameter
 - If available the parameter data of the corresponding module may be shown.
- Diagnosis
 - Configuration State
The current configuration status is shown here.
 - Diagnosis Entries
Here all pending diagnostic messages are shown.
 - Diagnosis Buffer
Here the content of the diagnostics buffer is listed.

Expert View

[Expert View] takes you to the advanced "Expert View".

HARDWARE		Hardware
MxFile	MX000006.110	Hardware information
ASIC/FPGA Version	V208	

PROFINET Connections		PROFINET connections
1	IP: 96.140.20.172 / Name: pn-io-2	Support information

4.6 Free Module Mapping (FMM)

4.6.1 Overview

FMM

- With FMM you can use PROFINET IO devices with different hardware variants without adapting your user program. You only have to adapt the FMM configuration in the PROFINET IO device when configuring the hardware variants. Here you have the following possibilities:
 - Modules from the target configuration can be divided in any order to the slots of the actual configuration.
 - Modules from the target configuration may be missing in the actual configuration.
 - Individual slots of the target configuration can be deactivated, on which modules are located in the actual configuration.
- FMM is a functionality of Yaskawa and is only supported by Yaskawa PROFINET IO device.
- By default, FMM is disabled. To use the FMM mappings, you have to activate FMM in the parametrization of the PROFINET IO device. ↪ *Chap. 4.4.1 'Parameter data' page 65*
- For the *FMM* the mapping of the slots is to be specified via the record set 0x7F.
- For commissioning, you have to activate the parameter '*Startup when expected/actual configuration differs*' because during the commissioning without FMM, the IO device responds to the CPU with a 1:1 mapping.
- If FMM is activated and configured correctly, the system reacts as follows:
 - During start-up, no target/actual difference of the hardware is diagnosed.
 - Output data of missing modules are ignored and not output.
 - Input data of missing modules are set to 0.

4.6.2 FMM configuration

Configuration

- The mapping of the modules is defined as configuration by the 64byte record set 0x7F.
- The record set is remanent stored in the PROFINET IO device, but not sent from the PROFINET controller to the IO device during the connection setup.
- Read and write access to the configuration is only possible if you have activated FMM in the parametrization of the PROFINET IO device, before.
- The record set must be transferred from the user program to the PROFINET IO device by a write command.
- With the record set read command parts of the active configuration can be read. You have always to write the complete record set.
- Each written and valid configuration is only saved if a difference to the existing configuration exists.
- Only after a restart the configuration gets activated.
- In the parametrization of the PROFINET IO device you can set that the IO device is restarted with the receipt of a configuration. Otherwise you have to manually reboot your IO device after the transfer of your configuration.

Record set 0x7F

Record set 0x7F

Byte	0	1	2	3	...	63
Mapping						

The following values can be entered at *Mapping*:

- 0: The slot is empty.
- 1...64: Slot which corresponds to the current hardware configuration (actual configuration).
- 255: Virtual module - module does not exist in the actual configuration.

Behaviour of a *virtual module*:

- The input area always has the value 0, regardless of its size.
- The writing to the output area has no effect.
- The following record sets can be read:
 - 0x8028: Read input data - always 0 is read.
 - 0x8029: Read output data - always 0 is read.
 - 0xAFF0: IM0 data - a name determined of the module ID is returned. To identify the virtual module, the name consists of the first 3 digits of the module type and the added "-XXXXX" (e.g.: 031-XXXXX). As SW/HW version you get these of the IO device.

Other record sets are negatively acknowledged. The connection setup remains unaffected by this.

Commissioning

The *target configuration* serves as template for the configuration of hardware variants.

1. ➤ Configure your system with a hardware configuration as target configuration and create your user program. The target configuration represents a superset of all available hardware variants.
2. ➤ Open the PROFINET configuration tool in your project.
3. ➤ Configure in your PROFINET IO device the FMM functionality:
 - Activate FMM
 - Activate if you want the automatic restart of the IO device with the receipt of a configuration. Otherwise you have to manually restart it.

4. ➤ For commissioning, you have to activate the parameter *'Startup when expected/ actual configuration differs'* because during the commissioning without FMM, the IO device responds to the CPU with a 1:1 mapping.
5. ➤ Create in your machine application for the configuration record set a memory area, which can be accordingly manipulated by the user program and transferred to your IO device. This can be realized e.g via a MMI in a protected area.
6. ➤ Create the configuration by defining the deviation of the actual and target configuration for the current hardware configuration in record set 0x7F.
7. ➤ Transfer this record set via write command to your IO device.
 - ⇒ The configuration is stored permanently in the IO device and active with the next restart.

4.6.3 Examples

4.6.3.1 Target configuration

Sample application



The FMM configuration always refers to the slot of the target configuration.

Slot _{target}	Module
1	DI
2	DO
3	DIO
4	AI
5	AO
6	CP

4.6.3.2 Examples of hardware variants

Based on the target configuration, the following examples show how to determine the FMM values for the hardware variants.

Variant 1: Same type and number of modules but reversed slots

(1): Target configuration	Slot _{target}	Module _{target}	Slot _{actual}	Module _{actual}	FMM
Slot: 1 2 3 4 5 6	1	DI	2	DO	2
①	2	DO	1	DI	1
	3	DIO	3	DIO	3
	4	AI	5	CP	5
	5	AO	6	AI	6
②	6	CP	4	AO	4

Determination of FMM

- Slot 1: The module of $Slot_{target} = 1$ is in the actual configuration at $Slot_{actual} = 2 \rightarrow FMM = 2$
- Slot 2: The module of $Slot_{target} = 2$ is in the actual configuration at $Slot_{actual} = 1 \rightarrow FMM = 1$
- Slot 3: The module of $Slot_{target} = 3$ is in the actual configuration at $Slot_{actual} = 3 \rightarrow FMM = 3$
- Slot 4: The module of $Slot_{target} = 4$ is in the actual configuration at $Slot_{actual} = 5 \rightarrow FMM = 5$
- Slot 5: The module of $Slot_{target} = 5$ is in the actual configuration at $Slot_{actual} = 6 \rightarrow FMM = 6$
- Slot 6: The module of $Slot_{target} = 6$ is in the actual configuration at $Slot_{actual} = 4 \rightarrow FMM = 4$

Record set 0x7F

Mapping	2	1	3	5	6	4	0	0	...	0
---------	---	---	---	---	---	---	---	---	-----	---

- Slot_{target} - The FMM configuration always refers to the slot of the target configuration.
- Module_{target} - Module at the slot of the target configuration.
- Slot_{actual} - Slot of the actual configuration.
- Module_{actual} - Module at the slot of the actual configuration.
- FMM - For variant 1, *FMM* corresponds to $Slot_{actual}$ i.e. slot of the actual configuration on which the module of the target configuration is located. *FMM* must be adapted when configuring the hardware variant.

Variant 2: Reversed slots and modules are missing

(1): Target configuration (2): Actual configuration	Slot _{target}	Module _{target}	Slot _{actual}	Module _{actual}	FMM
	1	DI	1	DI	1
	2	DO	-	DIO	255
	3	DIO	2	AI	2
	4	AI	3	AO	3
	5	AO	4		4
	6	CP	-		255

Determination of FMM

- Slot 1: The module of $Slot_{target} = 1$ is in the actual configuration at $Slot_{actual} = 1 \rightarrow FMM = 1$
- Slot 2: The module of $Slot_{target} = 2$ is not available in the actual configuration \rightarrow Mapping = 255
- Slot 3: The module of $Slot_{target} = 3$ is in the actual configuration at $Slot_{actual} = 2 \rightarrow FMM = 1$
- Slot 4: The module of $Slot_{target} = 4$ is in the actual configuration at $Slot_{actual} = 3 \rightarrow FMM = 3$
- Slot 5: The module of $Slot_{target} = 5$ is in the actual configuration at $Slot_{actual} = 4 \rightarrow FMM = 4$
- Slot 6: The module of $Slot_{target} = 6$ is not available in the actual configuration \rightarrow Mapping = 255

Record set 0x7F

Mapping	1	255	2	3	4	255	0	0	...	0
---------	---	-----	---	---	---	-----	---	---	-----	---

- Slot_{target} - The FMM configuration always refers to the slot of the target configuration.
- Module_{target} - Module at the slot of the target configuration.
- Slot_{actual} - Slot of the actual configuration.
- Module_{actual} - Module at the slot of the actual configuration.
- FMM - For variant 2, *FMM* corresponds to $Slot_{actual}$ i.e. slot of the actual configuration on which the module of the target configuration is located. If a module from the target configuration is missing, for *FMM* the value 255 for "virtual module" is to be used.

Variant 3: Modules are ignored

(1): Target configuration (2): Actual configuration	Slot _{target}	Module _{target}	Slot _{actual}	Module _{actual}	FMM
	1	DI	empty	-	0
	2	DO	empty	-	0
	3	DIO	3	DIO	3
	4	AI	4	AI	4
	5	AO	5	AO	5
	6	CP	6	CP	6

Determination of FMM

- Slot 1: The module of $Slot_{target} = 1$ is ignored in the actual configuration $\rightarrow FMM = 0$
- Slot 2: The module of $Slot_{target} = 2$ is ignored in the actual configuration $\rightarrow FMM = 0$
- Slot 3: The module of $Slot_{target} = 3$ is in the actual configuration at $Slot_{actual} = 3 \rightarrow FMM = 3$
- Slot 4: The module of $Slot_{target} = 4$ is in the actual configuration at $Slot_{actual} = 4 \rightarrow FMM = 4$
- Slot 5: The module of $Slot_{target} = 5$ is in the actual configuration at $Slot_{actual} = 5 \rightarrow FMM = 5$
- Slot 6: The module of $Slot_{target} = 6$ is in the actual configuration at $Slot_{actual} = 6 \rightarrow FMM = 6$

Record set 0x7F

Mapping	0	0	3	4	5	6	0	0	...	0
---------	---	---	---	---	---	---	---	---	-----	---

- Slot_{target} - The FMM configuration always refers to the slot of the target configuration.
- Module_{target} - Module at the slot of the target configuration.
- Slot_{actual} - Slot of the actual configuration.
- Module_{actual} - Module at the slot of the actual configuration.
- FMM - For variant 3, *FMM* corresponds to $Slot_{actual}$ i.e. slot of the actual configuration on which the module of the target configuration is located. If modules of the target configuration are to be ignored, *FMM* must be set to 0.



The presence of gaps in the System SLIO is not allowed! But you can place modules and define them via the configuration as empty slot for the target hardware configuration.

4.7 Easy Maintenance

Overview

Easy Maintenance means the support for adding and removing System SLIO modules during operation without having to restart the system. There are the following behaviors:

- *Easy Maintenance at active* bus connection
 - The bus cable is plugged and the IM 053-1PN01 is active on the bus.
 - As soon as a module is removed, the IM 053-1PN01 detects this, switches automatically maintenance mode and reports a diagnostic interrupt. In this mode, all input and output data become invalid. By re-plugging the module or a compatible module, the maintenance mode is left again.
 - As soon as a module is added to the existing modules, the IM 053-1PN01 detects this and automatically refreshes its reference configuration.
- *Easy Maintenance at passive* bus connection
 - The bus cable is removed.
 - As soon as a module is removed, the IM 053-1PN01 detects this and automatically refreshes its reference configuration.
 - As soon as a module is added to the existing modules, the IM 053-1PN01 detects this and automatically refreshes its reference configuration.

4.7.1 Examples









4.7.1.1 Module is removed with active bus connection

If a module is removed during an active bus connection, the IM 053-1PN01 behaves as follows:

1. ➤ Diagnostic interrupt_{incoming} is sent.
 - ⇒ Channel-specific error: System SLIO: Error on System SLIO bus (01Ch).
2. ➤ Diagnostic interrupt_{incoming} is sent.
 - ⇒ Channel-specific error: Invalid reference configuration (maintenance mode) (0120h).
3. ➤ Data of all modules are marked as invalid (IOPS/IOCS = state BAD). You get a periphery access error. In this case, OB 122 is called.
4. ➤ *Pull interrupt* is sent for the pulled module and the following modules (only configured modules) and OB 83 is called.
5. ➤ The System SLIO backplane bus is refreshed.
6. ➤ Diagnostic interrupt_{outgoing} is sent.
 - ⇒ Channel-specific error: System SLIO: Error on System SLIO bus (01Ch).
 - ⚡ *ChannelErrorTypes*
 - The SF-LED lights up (configuration error).
 - The MT-LED lights up (maintenance mode).









4.7.1.2 Compatible module is added again when the bus connection is active

If a compatible module is inserted into the slot of a previously removed module during an active bus connection, the IM 053-1PN01 behaves as follows:

1.  Diagnostic interrupt_{incoming} is sent.
 - ⇒ Channel-specific error: System SLIO: Error on System SLIO bus (01Ch).
2.  The System SLIO backplane bus is refreshed.
3.  Diagnostic interrupt_{outgoing} is sent.
 - ⇒ Channel-specific error: System SLIO: Error on System SLIO bus (01Ch).
4.  Diagnostic interrupt_{outgoing} is sent.
 - ⇒ Channel-specific error: Invalid reference configuration (maintenance mode) (0120h).  *ChannelErrorTypes*
5.  Data of all modules are marked as valid (IOPS/IOCS = state GOOD) - no periphery access error.
6.  *Plug interrupt* is sent for the inserted module and the following modules (only configured modules) and OB 83 is called.
7.  *ReturnOfSubModule interrupt* is sent for all other modules (only configured modules) and OB 83 is called.
 - ⇒ The SF LED turns off.
 - The MT-LED turns off.







4.7.1.3 Incompatible module is added again when the bus connection is active

If an incompatible module is inserted into the slot of a previously removed module during an active bus connection, the IM 053-1PN01 behaves as follows:

1.  Diagnostic interrupt_{incoming} is sent.
 - ⇒ Channel-specific error: System SLIO: Error on System SLIO bus (01Ch).
2.  The System SLIO backplane bus is refreshed.
3.  Diagnostic interrupt_{outgoing} is sent.
 - ⇒ Channel-specific error: System SLIO: Error on System SLIO bus (01Ch).
4.  Diagnostic interrupt_{outgoing} is sent.
 - ⇒ Channel-specific error: Invalid reference configuration (maintenance mode) (0120h).  *ChannelErrorTypes*
5.  Data of all modules, except that of the wrong module, are marked as valid (IOPS/IOCS = state GOOD) - no periphery access error.
6.  *Plug interrupt* is sent for the inserted module and the succeeding modules (only configured modules) and OB 83 is called.
7.  *ReturnOfSubModule* interrupts are sent for all other modules (only configured modules) and OB 83 is called.
 - ⇒ The SF-LED remains on (configuration error).
 - The MT-LED turns off.

4.7.1.4 Unconfigured modules are added to the existing modules when the bus connection is active

If one or more modules, which are not configured, are added to the existing modules during an active bus connection, the IM 053-1PN01 behaves as follows:

1.  Diagnostic interrupt_{incoming} is sent.
 - ⇒ Channel-specific error: System SLIO: Error on System SLIO bus (01Ch).
2.  Diagnostic interrupt_{incoming} is sent.
 - ⇒ Channel-specific error: Invalid reference configuration (maintenance mode) (0120h).
3.  Data of all modules are marked as invalid (IOPS/IOCS = state BAD). You get a periphery access error. In this case, OB 122 is called.
4.  The System SLIO backplane bus is refreshed.
5.  Diagnostic interrupt_{outgoing} is sent.
 - ⇒ Channel-specific error: System SLIO: Error on System SLIO bus (01Ch).
↳ *ChannelErrorTypes*
6.  Diagnostic interrupt_{outgoing} is sent.
 - ⇒ Channel-specific error: Invalid reference configuration (maintenance mode) (0120h).
7.  Data of all modules are marked as valid (no periphery access error).
 - ⇒ The SF LED remains off (no diagnostics).
The MT LED remains off.

4.7.1.5 Modules are added or removed when the bus plug is removed

If modules are added or removed, when the bus plug is removed, the IM 053-1PN01 behaves as follows:

-  The change is detected automatically and the reference configuration is refreshed.
 - ⇒ The SF LED remains off (no diagnostics).
The MT LED remains off.

4.8 Isochronous mode (IRT)

IRT Communication

- IRT means Isochronous **Real-Time**.
- With the IRT communication the bus cycle begins clock-exactly i.e. with a maximum permissible tolerance and is again synchronized. Thereby the time-controlled and synchronous transfer of data is guaranteed.
- Here sync telegrams of a sync master in the network serve for.

PROFINET class 3 (IRT)



Supported System SLIO modules

- Please note that IRT is only supported by System SLIO peripheral modules with FPGA version starting from V228. As soon as there is a peripheral module, which does not support IRT, you receive the diagnostic message 001Eh "System SLIO: Version error". In addition, this is indicated by the LEDs SF and MT. ↪ Chap. 3.2.2 'LEDs' page 51
- Via the Web server, you can use 'Expert view' to get the FPGA version of the corresponding peripheral module. Via 'Diagnosis' its diagnostic messages can be accessed. ↪ Chap. 4.5 'Web server' page 67

- Synchronized communication within a subnet.
- The topology, i.e. the sequence of the process data to be sent, must be specified in the engineering tool. This is checked at runtime in the devices. Only if the topology fits at runtime, data is transferred.
- With PROFINET class 3, a part of the available send clock is reserved for real-time tasks. Here, the send clock is divided into a "red", "yellow" and a "green" interval.
 - Only RT class 3 packets may be forwarded through switches in the red interval.
 - Communication in the red interval is based on a fixed schedule in advance. The schedule is based only on the sequence of incoming frames, which is determined by their *Frame-ID* and *Frame length*.
 - In the yellow interval, the switch accepts only jobs that can be completely transported before the start of the next red interval. If the forwarding of these jobs is not ensured, these frames are buffered and sent in the next green interval.
 - Within the green (open) interval, all other non-critical packets can be sent.
- To enable isochronous communication, acyclic services should be avoided and diagnostic alarms should be limited to its essentials.

IM 053-1PN01





The possibility to reach the refresh time of 250µs with IRT with isochronous mode depends on the used PROFINET controller.

- The IM 053-1PN01 supports PROFINET class 3 for applications with cycle times of $\geq 250\mu\text{s}$ and a jitter of $<1\mu\text{s}$.
- In addition to isochronous mode on the PROFINET level, the IM 053-1PN01 supports isochronous transmission of the data on the backplane bus.
 Within an isochronous system, the System SLIO μs tickers are synchronized by the PROFINET controller. This allows, e.g. the cross-station use of System SLIO ETS modules (ETS = **e**dge **t**ime **s**tamp). In the case of an ETS input module, the value of the μs ticker is saved with each edge change of the input signal. For an ETS output module, the outputs can be synchronized using the μs ticker.

System SLIO μ s ticker in application

The isochronous μ s tickers can be configured as a "virtual" module for each System SLIO PROFINET IO device.

1.  In the hardware configuration, place the "virtual" module 'xTsTicker Timestamp Sync' from the GSDML file.

2.  Assign this an address range.

3.  Transfer your project into the PROFINET controller.

⇒ After transferring your project, there the value of the System SLIO μ s ticker is stored isochronously and can thus be further processed in the application.

If the time value of the System SLIO μ s ticker is to be stored only "cyclically", the virtual module 'xTsTicker Timestamp' must be used.

4.9 Firmware update



- Please note that a firmware update is only possible if no active connection to the PROFINET controller is established.
- You can apply a firmware update via the integrated web server.
↳ 'Firmware update' page 69

4.10 Replacement PROFINET IM 053-1PN00 by IM 053-1PN01



The PROFINET IO device IM 053-1PN01 is compatible with the IM 053-1PN00.

- A direct device replacement without adjustments is possible provided that device-specific I&M data is neither used nor evaluated for identification or in the control application. ↳ Chap. 4.13 'I&M data' page 91
- To use the isochronous mode (IRT), the GSDML file must be used for the IM 053-1PN01.

4.11 Device replacement without exchangeable medium/PG

Overview

IO devices, which support the PROFINET function *Device replacement without exchangeable medium/PG* get their device name from the controller with the exchange. These can be replaced without installing an "exchangeable medium" (memory card) with the stored device name respectively without assigning a device name by a PG. To assign the device name the IO controller uses the configured *Topology* and the "neighbourhood relationship", which is determined by the IO devices.

Thus the *Device replacement without exchangeable medium/PG* is possible, the following requirements must be met:

- The *Topology* of your PROFINET IO system with the corresponding IO devices must be configured.
- The IO controller and the respective adjacent to the unit to be replaced IO device must support the functionality *Device replacement without exchangeable medium/PG*.
- In the IO controller in the '*Properties*' the option *Support device replacement without exchangeable medium* must be enabled.
- The replaced device must be reset to delivery state, before.

Configuring the function

The configuration of the function *Device replacement without exchangeable medium/PG* in your PROFINET IO system happens with the following approach:

1. ➤ Double-click at the PROFINET interface of the IO controller of the CPU.
⇒ The properties dialog of this PROFINET interface is opened
2. ➤ Enable in the register '*General*' the option '*Support device replacement without exchangeable medium*'.
3. ➤ Apply the settings with [OK].
4. ➤ Save and translate the hardware configuration.
5. ➤ Configure your *Topology*.
6. ➤ Transfer your project to the CPU.

4.12 Hardware and diagnostic interrupt

4.12.1 Hardware interrupt

- Hardware interrupt data of System SLIO modules with interrupt capability were automatically sent by a diagnostics message if the interrupt is activated by parametrization at the corresponding module respectively at the System SLIO PROFINET IO device.
- On an hardware interrupt your master system jumps into an interrupt routine. There you can read the hardware interrupt data by means of the block SFB 54 - RALARM.

Hardware interrupt data

Byte	Description	Example	Content
0..1	AlarmNotification (1: High, 2: Low)	0002h	PROFINET interrupt data
2..3	BlockLength	001Eh	
4..5	Version High/Low	0100h	
6..7	AlarmType (1: Diagnostics, 2: Process, 3: Pull)	0002h	
8..11	API	0000h, 0000h	
12..13	Slot	0003h	
14..15	Subslot	0001h	
16..19	ModuleIdentNumber	0006h, 1F41h	
20..23	SubmoduleIdentNumber	0000h, 0001h	
24..25	DiagnosticsState (PROFINET specific IEC 61158-6-10)	0005h	
26..27	UserStructureIdentifier 0000h ... 7FFFh: UserSpecifiedDiagnostics 1000h: Hardware interrupt (product specific) 8000h: ChannelDiag 8002h: ExtChannelDiag	1000h	
28..47	Product specific: Hardware interrupt data	...	Hardware interrupt data (see module description)
48..49	Product specific: Slot/SubSlot	0101h	Slot 1/SubSlot 1
50..51	Product specific: Channel 0000h..7FFFh: UserSpecific 8000h: SubSlotSpecific	0001h	Channel 1

4.12.2 Diagnostic interrupt

- Diagnostics interrupt data of System SLIO modules with interrupt capability were automatically sent by a diagnostics message if the interrupt is activated by parametrization at the corresponding module respectively at the System SLIO PROFINET IO device.
- On a diagnostics interrupt your master system jumps into an interrupt routine. There you can read the diagnostics interrupt data by means of the block SFB 54 - RALARM.
- The interrupt behavior and the structure of the diagnostics data may be preset by the parametrization of the System SLIO PROFINET IO device. Among others you have the choice between the following diagnostics data:
 - UserSpecifiedDiagnostics
Here all the diagnostics data can be accessed.
 - ExtendedChannelDiagnostics (channel-specific)
Here record set 0 of the diagnostics data (4byte) may be accessed. Additional diagnostics data must explicit be requested.

4.12.2.1 UserSpecifiedDiagnostics (*vendor specific*)

Byte	Description	Example	Content	
0..1	AlarmNotification <ul style="list-style-type: none"> ■ 1: High ■ 2: Low 	0001h	PROFINET interrupt data (header)	
2..3	BlockLength	0030h		
4..5	Version High/Low	0100h		
6..7	AlarmType <ul style="list-style-type: none"> ■ 1: Diagnostics ■ 2: Process ■ 3: Pull 	0001h		
8..11	API	0000h, 0000h		
12..13	Slot	0001h		
14..15	Subslot	0001h		
16..19	ModuleIdentNumber	0403h, 1543h		
20..23	SubmoduleIdentNumber	0000h, 0001h		
24..25	DiagnosticsState (PROFINET specific IEC 61158-6-10)	B001h		
26..27	UserStructureIdentifier <ul style="list-style-type: none"> ■ 0000h ... 7FFFh: UserSpecifiedDiagnostics <ul style="list-style-type: none"> – Product specific (UserSpecifiedDiagnostics): Offset + ChannelErrorType – Offset: 0000h: Error at PROFINET IO device 01F4h: Error at System SLIO module ■ 8002h: ExtChannelDiag <ul style="list-style-type: none"> – (refer to the table below) 	01FBh		UserSpecifiedDiagnostics 01FBh = 01F4h + 7h Error at System SLIO module, ChannelErrorType: 7 (Upper limit exceeded)
28..47	Product specific: Diagnostic interrupt data (DS 1)	...		Diagnostic record set 1 (see module description)

Hardware and diagnostic interrupt > Diagnostic interrupt

Byte	Description	Example	Content
48..49	Product specific: Slot/Subslot	0101h	Slot 1/Subslot 1
50..51	Product specific: Channel <ul style="list-style-type: none"> ■ 0000h ... 7FFFh: UserSpecific ■ 8000h: SubSlotSpecific - for every channel 	0001h	Channel 1

4.12.2.2 ExtendedChannelDiagnostics (*channel specific*)

Byte	Description	Example	Content
0..1	AlarmNotification <ul style="list-style-type: none"> ■ 1: High ■ 2: Low 	Example	PROFINET interrupt data (header)
2..3	BlockLength	Example	
4..5	Version High/Low	Example	
6..7	AlarmType <ul style="list-style-type: none"> ■ 1: Diagnostics ■ 2: Process ■ 3: Pull 	Example	
8..11	API	0000h, 0000h	
12..13	Slot	0001h	
14..15	Subslot	0001h	
16..19	ModuleIdentNumber	0403h, 1543h	
20..23	SubmoduleIdentNumber	0000h, 0001h	
24..25	DiagnosticsState <ul style="list-style-type: none"> ■ (PROFINET specific IEC 61158-6-10) 	A807h	
26..27	UserStructureIdentifier <ul style="list-style-type: none"> ■ 0000h ... 7FFFh: UserSpecifiedDiagnostics ■ 8002h: ExtendedChannelDiagnostics 	8002h	ExtendedChannelDiagnostics
28..29	Channel <ul style="list-style-type: none"> ■ 0000h ... 7FFFh: UserSpecific ■ 8000h: SubSlotSpecific - for every channel 	0001h	Channel 1
30..31	ChannelProperties <ul style="list-style-type: none"> ■ (PROFINET specific IEC 61158-6-10) 	2805h	Channel properties: Input, 16bit, interrupt _{incoming}
32..33	ChannelErrorType (see table):	0007h	Upper limit violation
34..35	Product specific: ExtendedChannelErrorType <ul style="list-style-type: none"> ■ 0000h: Error at PROFINET IO device ■ 01F4h: Error at System SLIO module 	01F4h	Error at System SLIO module
36..39	Product specific: ExtendedChannelAddValue <ul style="list-style-type: none"> ■ Diagnostic data 4bytes (DS 0) 	0000h..150Dh	Diagnostic data record set 0 (see module description)

4.12.2.3 ChannelErrorTypes

Code	Description
0001h	Short circuit
0002h	Under-voltage (supply voltage)
0003h	Over-voltage (supply voltage)
0004h	Output module is overloaded
0005h	Temperature rise output module
0006h	Wire break sensors or actors
0007h	Upper limit violation
0008h	Lower limit violation
0009h	Error (Load voltage at the output, sensor supply, hardware error)
000Ah	Simulation active
0010h	Parametrization error
0011h	Sensor or load voltage missing
0012h	Fuse defect
0013h	Communication errors
0014h	Ground fault
0015h	Reference channel error
0016h	Hardware interrupt lost
0017h	Threshold interrupt
0018h	The outputs are disabled
0019h	Safety-related shutdown
001Ah	External error
001Bh	Indefinable error - not specified
001Ch	System SLIO: Error on System SLIO bus
001Dh	System SLIO: Parameter could not be written
001Eh	System SLIO: Version error
0101h	IO device: Unexpected restart
0102h	Safety: Channel cross-circuit detected
0103h	Safety: Safety module I Parameter fault detected
0104h	Safety: Safety module F Parameter fault detected
0105h	Safety: Safety module F-address EEPROM unequal DIP switch
0106h	Safety: Safety module F-address in EEPROM has been reset
0107h	Safety: Channel discrepancy detected
0108h	Shared device error - shared device is not supported by this hardware version.
0109h	FMM configuration was changed - manual restart necessary.
0120h	Invalid reference configuration (Maintenance Mode) Occurs when modules are pulled / unplugged during operation.  <i>Easy Maintenance</i>

4.12.2.4 Acyclic access to the diagnostic data

By means of the handling block SFB 52 - RDREC the last sent diagnostics data can acyclically be read from the module.

4.12.2.4.1 Diagnostic PROFINET IO device

Access

With *Slot* = 0 / *Subslot* = 1 the PROFINET IO device is accessed. Depending on the *Index* you will get the following data:

- *Index* = 0000h: 4byte
 - Byte 0: Diagnostic byte 1
 - Byte 1: Diagnostic byte 2
 - Byte 2 ... 3: 0 (fix)
- *Index* = 0001h: 20byte
 - Byte 0: Diagnostic byte 1
 - Byte 1 ... 19: 0 (fix)

Structure

Byte	Bit 7 ... Bit 0
0	Diagnostic byte 1 <ul style="list-style-type: none"> ■ Bit 0: Error on System SLIO bus ■ Bit 1: Parameter could not be written into the IO device. ■ Bit 2: General parameter error IO device. ■ Bit 3: Version error at the System SLIO bus (at least one module is not supported at the System SLIO bus). ■ Bit 4: Unexpected restart was performed. ■ Bit 5: Port monitoring (data transmission impossible according PROFINET IEC 61158). ■ Bit 6: Port monitoring (remote mismatch according PROFINET IEC 61158). ■ Bit 7: Configuration error System SLIO bus (Actual configuration differs from expected configuration).
1	Diagnostic byte 2 <ul style="list-style-type: none"> ■ Bit 0: Module was removed. ■ Bit 1: Shared device error. Shared device is not supported by this hardware version. ■ Bit 2: FMM configuration was changed - manual restart necessary. ↪ <i>Chap. 4.6 'Free Module Mapping (FMM)' page 72</i> ■ Bit 7 ... 3: 00h (fix)
2 ... 3 (19)	00h (fix)

4.12.2.4.2 Diagnostics data module

Access

With *Slot* = 1 ... 64 / *Subslot* = 1 the corresponding System SLIO module is accessed. Depending on the *Index* you will get the following data:

- *Index* = 0000h
 - Record set DS 00h of the diagnostics data
- *Index* = 0001h
 - Record set DS 01h of the diagnostics data



Information concerning the allocation of these areas may be found in the description of the corresponding System SLIO module.

Structure

Name	Bytes	Function
ERR_A	1	Diagnostic
MODTYP	1	Module information
ERR_C	1	reserved
ERR_D	1	Diagnostic
CHTYP	1	Channel type
NUMBIT	1	Number diagnostics bits per channel
NUMCH	1	Number channels of the module
CHERR	1	Channel error
CHxERR	8	Channel-specific error channel x
DIAG_US	4	µs ticker

ERR_A Diagnostic

Byte	Bit 7 ... 0
0	<ul style="list-style-type: none"> ■ Bit 0: set at module failure ■ Bit 1: reserved ■ Bit 2: set at external error ■ Bit 3: set at channel error ■ Bit 4: set at external auxiliary supply missing ■ Bit 6 ... 5: reserved ■ Bit 7: set at error in parametrization

MODTYP Module information

Byte	Bit 7 ... 0
0	<ul style="list-style-type: none"> ■ Bit 3 ... 0: module class <ul style="list-style-type: none"> – 0101b: Analog module – 1000b: FM – 0111b: ETS, CP – 1111b: Digital module ■ Bit 4: set at channel information present ■ Bit 7 ... 5: reserved

ERR_C reserved

Byte	Bit 7 ... 0
0	reserved

ERR_D Diagnostic

Byte	Bit 7 ... 0
0	<ul style="list-style-type: none"> ■ Bit 5 ... 0: reserved ■ Bit 6: set at hardware interrupt lost ■ Bit 7: reserved

CHTYP Channel type

Byte	Bit 7 ... 0
0	<ul style="list-style-type: none"> ■ Bit 6 ... 0: Channel type <ul style="list-style-type: none"> – 70h: Digital input – 71h: Analog input – 72h: Digital output – 73h: Analog output – 74h: Analog input/-output – 76h: Counter ■ Bit 7: reserved

NUMBIT Diagnostic bits

Byte	Bit 7 ... 0
0	Number of diagnostic bits per channel.

NUMCH Channels

Byte	Bit 7 ... 0
0	Number of channels of a module.

CHERR Channel error

Byte	Bit 7 ... 0
0	<ul style="list-style-type: none"> ■ Bit 0: set at error in channel 0 ■ Bit 1: set at error in channel 1 ■ Bit 2: set at error in channel 2 ■ Bit 3: set at error in channel 3 ■ Bit 4: set at error in channel 4 ■ Bit 5: set at error in channel 5 ■ Bit 6: set at error in channel 6 ■ Bit 7: set at error in channel 7

CHxERR Channel specific error

Byte	Bit 7 ... 0
0	Information concerning the allocation may be found in the description of the corresponding System SLIO module.

DIAG_US μ s ticker

Byte	Bit 7 ... 0
0...3	Value of the μ s ticker at the moment of the diagnostic

 μ s ticker

In the System SLIO module there is a timer (μ s ticker). With PowerON the timer starts counting with 0. After $2^{32}-1\mu$ s the timer starts with 0 again.

4.13 I&M data

Overview

- I&M data are **I**dentification and **M**aintenance data. These data are stored in the module which support you at:
 - Check of the system configuration
 - Discover of hardware changes of a plant
 - Remove errors in a plant
- By means of I&M data the modules can online be identified.
- I data (**I**dentification data) are vendor information, which only can be read and which are printed in part at the module such as:
 - Order number
 - Serial number
- M data (**M**aintenance data) are plant dependent information. These are created during configuration and stored in the module such as:
 - Installation location
 - Installation data

I&M data

Via read record set special identification data may be accessed. Here parts of the identification data are addressed by the corresponding index number. The record sets have the following structure:

Contents	Length (byte)	Coding (hex)
Header		
■ BlockType	2	I&M0: 0020h I&M1: 0021h I&M2: 0022h I&M3: 0023h
■ BlockLength	2	I&M0: 0038h I&M1: 0038h I&M2: 0012h I&M3: 0038h
■ BlockVersionHigh	1	01h
■ BlockVersionLow	1	00h
Identification data (see the following table)	I&M0 / Index AFF0h: 54h I&M1 / Index AFF1h: 54h I&M2 / Index AFF2h: 16h I&M3 / Index AFF3h: 54h	

I&M data for PROFINET IO

Identification data	Access	Preset	Explanation
Identification data 0: (Index AFF0h)			
VendorIDHigh	read (1byte)	02h	Name of the manufacturer
VendorIDLow	read (1byte)	2Bh	(555 = YASKAWA Europe GmbH)
Order_ID	read (20byte)		Order number

I&M data

Identification data	Access	Preset	Explanation
IM_SERIAL_NUMBER	read (16byte)	-	Serial number
IM_HARDWARE_REVISION	read (2byte)	1	Hardware revision
IM_SOFTWARE_REVISION	read	Firmware version	Firmware version
■ SWRevisionPrefix	(1byte)	V, R, P, U, T	
■ IM_SWRevision_Functional_Enhancement	(1byte)	00h ... FFh	
■ IM_SWRevision_Bug_Fix	(1byte)	00h ... FFh	
■ IM_SWRevision_Internal_Change	(1byte)	00h ... FFh	
IM_REVISION_COUNTER	read (2byte)	0000h	for internal usage
IM_PROFILE_ID	read (2byte)	0000h	for internal usage
IM_PROFILE_SPECIFIC_TYPE	read (2byte)	0005h	for internal usage
IM_VERSION	read	0101h	Version of the I&M data (e.g. 0101h = version 1.1)
■ IM_Version_Major	(1byte)		
■ IM_Version_Minor	(1byte)		
IM_SUPPORTED	read (2byte)	000Eh	I&M1 ... I&M3 are present
Maintenance data 1: (Index AFF1h)			
IM_TAG_FUNCTION	read/write (32byte)	-	Unique device identification inside the system
IM_TAG_LOCATION	read/write (22byte)	-	Location of installation of the module
Maintenance data 2: (Index AFF2h)			
IM_DATE	read/write (16byte)	YYYY-MM-DD HH:MM	Date of installation of the module
Maintenance data 3: (Index AFF3h)			
IM_DESCRIPTOR	read/write (54byte)	-	Commentary to the module

4.14 Index overview

General

- Within a module the I/O, parameter and diagnostics data may be accessed by Index numbers.
- In PROFINET the *Index* numbers are grouped to the following areas:
 - 0000h ... 7FFFh: Vendor-specific *Index* numbers
 - 8000h ... F7FFh: Standard *Index* numbers from PROFINET
 Information concerning this are to be found in the PROFINET specification.
- The Index can be accessed via your master system by means of handling blocks to read and write record sets. More can be found in the operation list of your CPU.
 - ↳ *Chap. 4.3 'Accessing the System SLIO' page 59*

In the following is a list of all supported *index numbers*.

Index number

Index	Description
<i>Readable index numbers</i>	
0000h	read DS 00h diagnostic data (4byte)
0001h	read DS 01h diagnostic data (20byte)
007Dh	read the whole parameter data
007Eh	read DS 00h of the parameter data
007Fh ¹	read FMM Configuration ↳ <i>Chap. 4.6 'Free Module Mapping (FMM)' page 72</i>
007Fh ²	read DS 01h of the parameter data
0080h ... 0090h ²	read DS 80h ... DS 90h of the parameter data
8000h / 8001h / 800Ah / 800Bh / 800Ch / 8010h / 8011h / 8012h / 8013h / 801Eh / 802Ah / 802Bh / 802Ch / 802Dh / 802Fh / 8030h / 8031h / 8050h / 8051h / 8052h / 8053h / 8054h / 8060h / 8061h / 8062h / 8070h / 8080h / 8090h	refer to the PROFINET specification
8028h ²	read input data from a subplot
8029h ²	read output data from a subplot
AFF0h	read I&M 0 (serial number, name, SW/HW version)
AFF1h ¹	read I&M 1 (identification and location)
AFF2h ¹	read I&M 2 (date of installation)
AFF3h ¹	read I&M 3 (comment)
C000h / C001h / C00Ah / C00Bh / C00Ch / C010h / C011h / C012h / C013h / E000h / E001h / E002h / E00Ah / E00Bh / E00Ch / E010h / E011h / E012h / E013h / E030h / E040h / E050h / F000h / F001h / F00Ah / F00Bh / F00Ch / F010h / F011h / F012h / F013h / F020h / F80Ch / F820h / F821h / F830h / F831h / F840h / 8041h / F842h	refer to the PROFINET specification
<i>Writable Index numbers</i>	
0000h ²	write DS 00h of the parameter data
0001h ²	write DS 01h of the parameter data
007Dh	write the whole parameter data

Index overview

Index	Description
007Eh	write DS 00h of the parameter data
007Fh ¹	write FMM configuration ↗ <i>Chap. 4.6 'Free Module Mapping (FMM)' page 72</i>
007Fh ²	write DS 01h of the parameter data
0080h ... 0090h ²	write DS 80h ... DS 90h of the parameter data
AFF1h ¹	write I&M 1 (identification and location)
AFF2h ¹	write I&M 2 (date of installation)
AFF3h ¹	write I&M 3 (comment)
AFF4h ¹	write I&M 4 (sign in module EEPROM)

1) Only PROFINET IO device

2) Only System SLIO module

Appendix

Content

A	History of changes.....	97
----------	--------------------------------	-----------

A History of changes

Rev.	Changes
19-03	The manual was created.
19-40	General <ul style="list-style-type: none">■ CI adjustment was made. Chapter "Deployment" <ul style="list-style-type: none">■ Description "Replacement PROFINET IM 053-1PN00 by IM 053-1PN01" was changed.
21-18	Chapter "Basics and Mounting" <ul style="list-style-type: none">■ Description of the 16x periphery modules was added.■ Description "Hardware revision" was changed.■ Description "Industrial security and installation guidelines" was added.■ Description "System SLIO product variants for extended application range" was added. Chapter "Deployment" <ul style="list-style-type: none">■ Description "Replacement PROFINET IM 053-1PN00 by IM 053-1PN01" was changed.
22-30	General <ul style="list-style-type: none">■ CI adjustment was made. Chapter "Basics and Mounting" <ul style="list-style-type: none">■ Description "Hardware revision" was changed.■ Description "Use in difficult operating conditions" was added.